



APPENDIX to

PILOT PROJECT “CONTAIN” – Exploring the Challenges of Containership Fires



Authors

Thomas Hulin – Project Manager
Konrad Wilkens
Aqqalu Ruge
Carsten Møller
Darko Perovic
Nicklas S. Koch
Asgrimur Eiriksson
Alexander B. Kleiman

Thanks to

DMAIB - Øssur J. Hilduberg
BIMCO - Ashok Srinivasan
CEFOR - Helle Hamar
CODAN - Mikkel G. Andersen
Watson Farley & Williams, LLC - David Handley
Maersk Line
Odense Maritime Technology
Carsten Damgaard - DBI
Poul Bjerre Toftild - DBI
The Danish Maritime Fund

DBI – Danish Institute of Fire and Security Technology

Jernholmen 12, 2650 Hvidovre, Denmark

www.brandogsikring.dk, +45 36 34 90 00

APPENDIX A

1 Cone calorimeter tests

1.1 Apparatus

All tests were carried out in the cone calorimeter (Figure 1). In this apparatus a conical shaped heater emits radiant heat to a specimen which is positioned 25 mm below. The heat exposure is defined at the start of a test and remains constant throughout its duration. A spark ignitor is positioned above the sample to ignite any flammable gases, at which point the time to ignition is recorded. The post-combustion gases are collected and measured in the exhaust above to enable calculation of the amount of heat released by a material. The mass loss rate of a specimen is also recorded using a scale.

Specimens of dimensions 100 x 100 mm were placed under the cone heater in the horizontal orientation. Three different radiant heat levels were initially chosen – 50, 25 and 15 kW/m² – which correspond to high, medium and low levels of heat exposure respectively. An additional heat flux level of 35kW/m² was later added due to the uncertainty in ignition times recorded at 15kW/m². Tests were otherwise performed according to the standardised procedure given in ISO 5660.

In order to assess the performance of the plywood, there are a number of parameters which are evaluated. These are described in Table 1.

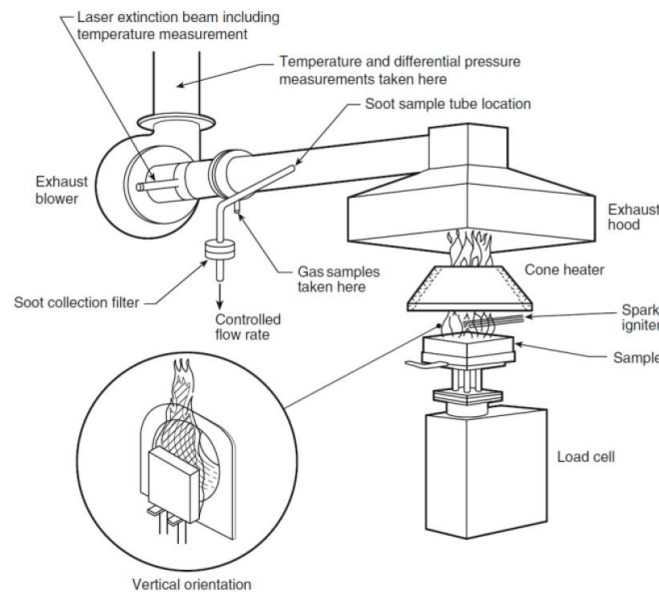

Figure 1 – schematic of cone calorimeter apparatus

Table 1 – List of key parameters obtained from the cone calorimeter

Key parameters	Description
----------------	-------------

Heat Release rate (kW/m ²), HRR	The HRR is the time dependent measured release of energy from the specimen as combustion takes place
Peak heat release rate (kW/m ²), PHRR	The peak heat release rate is a measurement of the greatest amount of heat release from a sample, which typically occurs shortly after ignition. It is often considered one of the most critical parameters since it can affect whether a room will develop from a small fire into whole room burning.
Time to ignition (s), tig	This gives a measure of the ignitability of a material. It is also critical in evaluating whether a material is capable of supporting flame spread, and whether a room will develop into whole room burning.
Total energy (heat) released (kJ), THR	A summation of the heat released over the full duration of burning. This gives an indication of how much the lining contributes to the fuel loading in a compartment.
Mass Loss Rate (kg/s), MLR	The rate at which mass is lost from the sample as it goes through the pyrolysis/combustion process.
Other terminology	
Incident heat flux (kW/m ²), IHF Also heat exposure, radiant heat flux, heat flux, heat level, radiation	Amount of heat transferred from the cone heater to the surface of the sample.

1.2 Materials

It was discovered when purchasing a container for experimental purposes, that the floor was not a single material, but was made up of a patchwork of various plywood sections – varying in age, condition, materials, and surface treatments as shown in Figure 2 below.



Figure 2 – floor of purchased container

Figure 3 illustrates where the various samples used for cone testing (blue numbered squares) and mobile furnace testing (white squares) were taken from the floor.

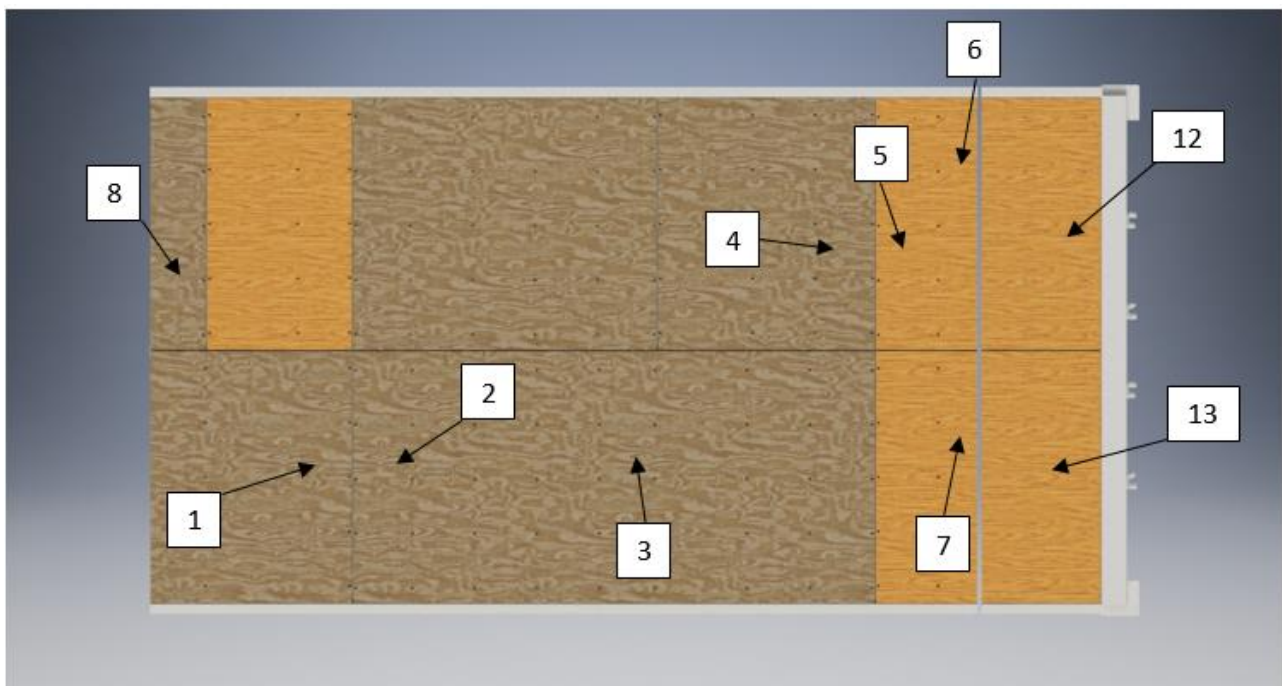

Figure 3 – schematic of floor where and location where samples were taken from Samples 2 and 3 taken from same plate

Sample 5 and 6 are taken from the same plate, Sample 7 and 13 are taken from the same plate. The plate where sample 12 is taken is a standalone plate. Figure 4 illustrates some examples of the differences in plywood materials extracted from the floor of the purchased container. Differences were not only visually observable, i.e. in appearance or having surface treatment (e.g. asphalt layer for water proofing) or not, densities were also recorded as varying significantly with values ranging between approximately 600 and 900 kg/m³.



Figure 4 – examples for plywood samples

1.3 Experimental design

A total of 41 experiments were performed in the cone calorimeter. Table 2 outlines the scenario tested (pilot or non-pilot ignition or damaged sample), the heat flux applied (in kW/m²) and the sample ID (X–Y) where ‘X’ indicates where the sample was taken from (refer Figure 3), and ‘Y’ is the sample number i.e. 6–2 indicates a sample taken from position 6, and is the 2nd sample tested from this location. Mass in grams is also included.

Table 2 – Experimental design

Scenario	heat flux	sample ID	Mass (g)
piloted ignition			
	15	6–2	194.9
	15	3–4	245.5
	15	12–4	210
	15	13–3	231.1
	15	5–3	192.3
	15	8–5	194.7
	25	3–2	258.9
	25	2–3	268.2
	25	3–3	263.9
	25	13–2	221.3
	25	4–1	258
	25	8–2*	201.9
	25	12–2*	218
	25	8–3	199.2
	25	6–1	208.6
	25	8–4	196.2
	25	12–3	226.6
	35	6–3	197.9
	35	4–2	247.4
	35	13–4	224.1
	35	3–5	244.3
	35	8–6	184.7
	35	12–5	219.4

	50	8—1	198.3
	50	3—1	260.2
	50	2--1	255
	50	2—2	260.5
	50	5—1	213
	50	12—1	222.1
	50	5—2	210.5
	50	1—1	239.8
	50	13—1	227.1
damaged samples			
	50	8-D-1	181
	50	12-D-1	216.9
	50	4-D-1	258.6
self-ignition (non-piloted)			
	50	12-S-1	200
	50	13-S-1	213.3
	50	8-S-1	188.1
	25	12-S-2*	228.9
	35	12-S-3	215.4
	35	8-S-2	181.5

* Some data was lost, or measurements malfunctioned in these tests, thus they are not included in the results section.

1.4 Results

Generally, based on the test data, there are two distinct phases of burning for each specimen. Upon ignition, there is a large amount of heat release (initial peak). Following this, a char layer forms and the rate of heat release drops significantly. Once the char reaches a certain thickness, there is a second phase where the burning is relatively constant or steady. Tests were run for between 20-30mins and not run until all of the materials was burned, this was mainly due to time constraints, and the observation of steady burning after the initial peak, which is expected to extend until close to material completion. Also, due to the test setup, it is generally considered that towards the end of a test, results are less reliable as artefacts from the test setup (i.e. the sample holder) begin to effect the results.

The results have been in described in more detail below, and have been separated for different heat exposures. Additionally, some analysis using key metrics is used across all exposures.

1.4.1 Heat Release Rate data

Figures presented below give a summary of results for the different heat exposures tested. Heat exposures presented represent a relatively “high” – 50kW/m², “medium-high” – 35kW/m², “medium” – 25kW/m² and “low” – 15kW/m².

High Heat Flux – 50kW/m²

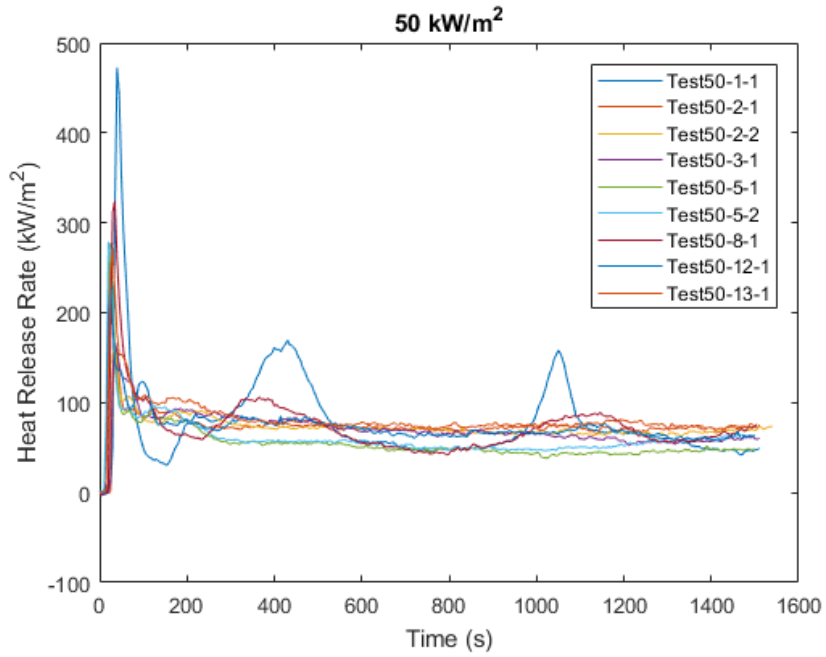

Figure 5 – heat release rate data from all samples tested

Medium-High Heat Flux – 35kW/m²

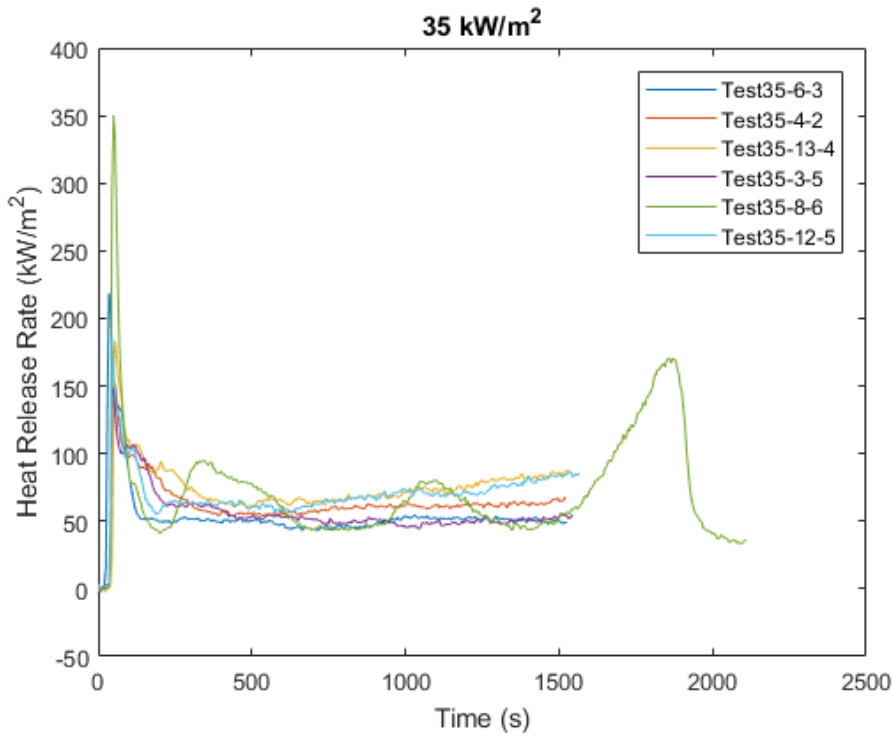

Figure 6 – heat release rate data from all samples tested

Medium Heat Flux – 25kW/m²

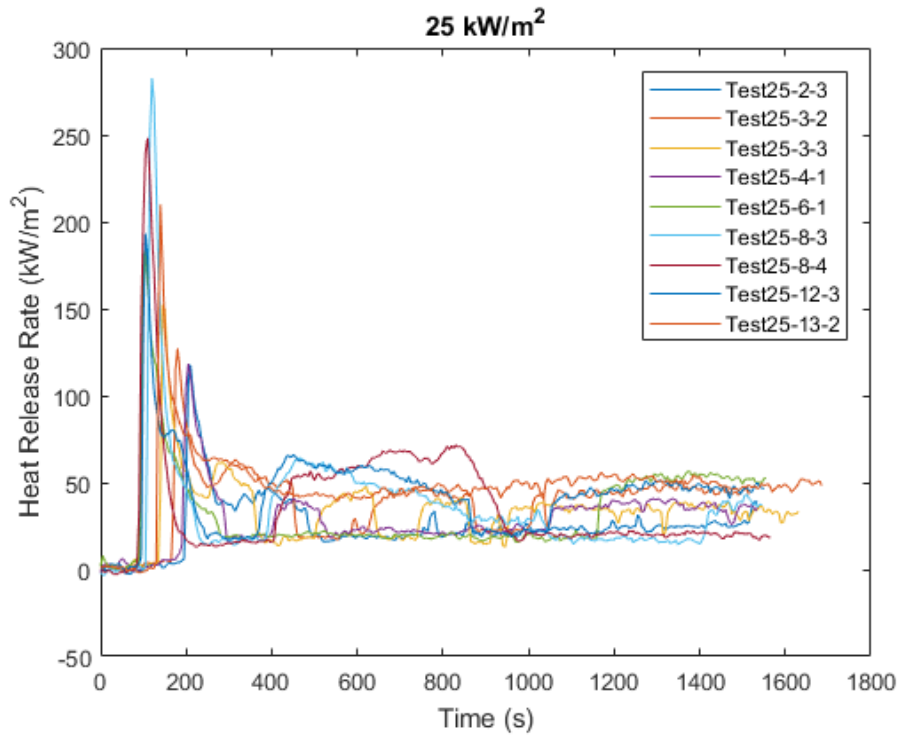

Figure 7 – heat release rate data from all samples tested

Low Heat Flux – 15kW/m²

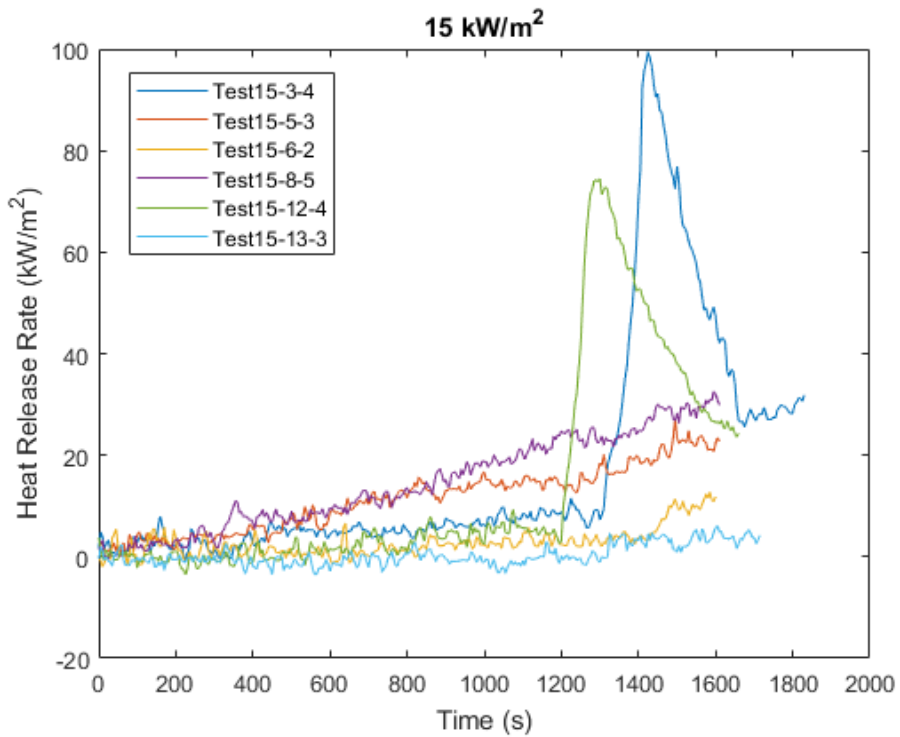

Figure 8 – heat release rate data from all samples tested

1.4.1.1 Individual sample results

In this section, we compare results for tests using individual sample material across the various tested heat fluxes. This is done to better highlight the performance/variation of these individual materials. An “individual material” is defined as the set of samples that were taken from one particular section of the floor as per Figure 3. Legends in the following figure can be read as follows: TestX-Y-Z, where X is the incident heat flux tested at (e.g. 50kW/m²), Y is the sample location, according to Figure 3 and Z is the test number e.g. “3” indicate this is the 3rd sample tested from this location.

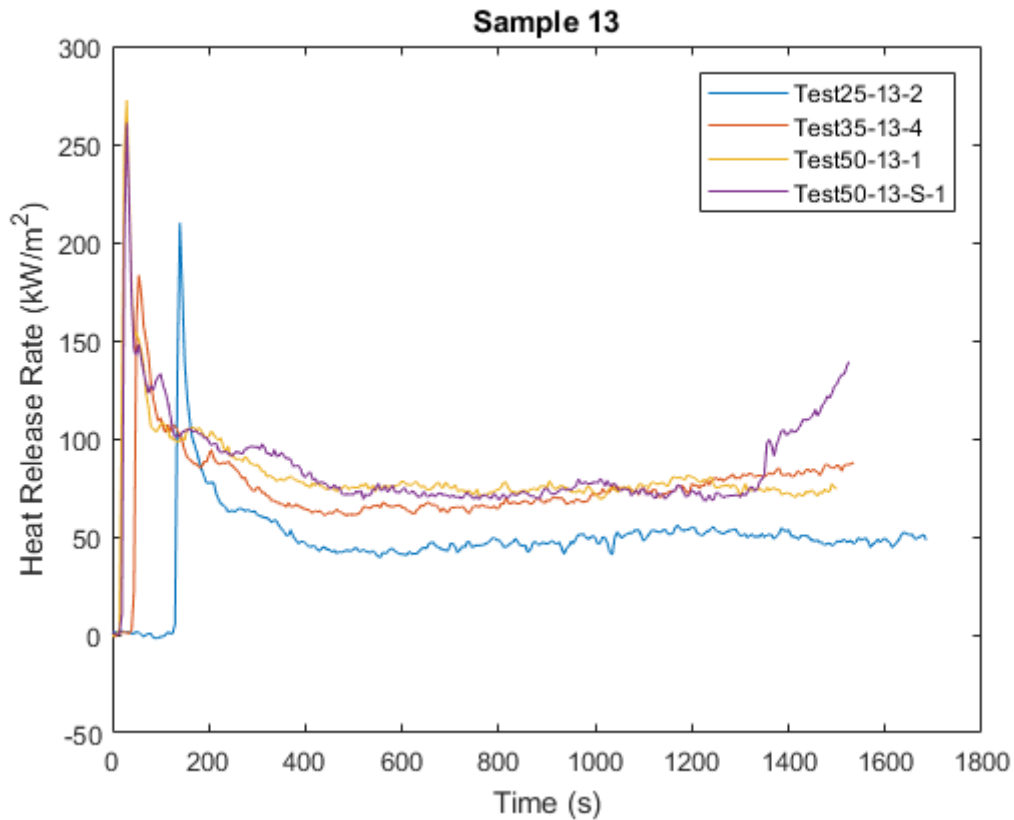

Figure 9

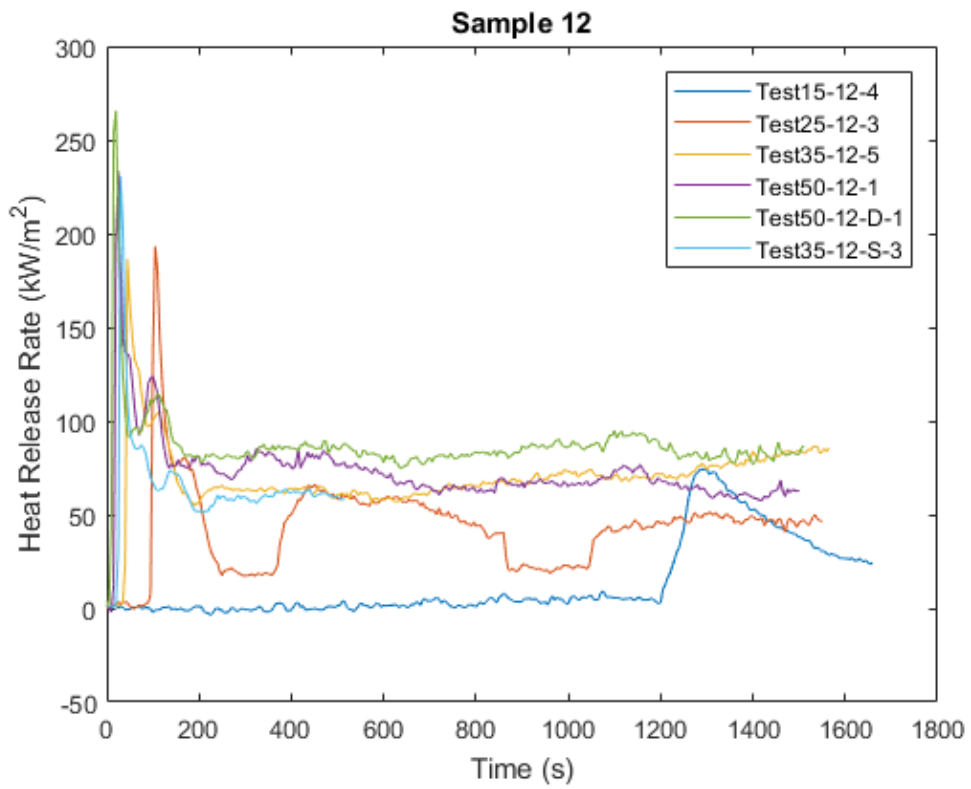

Figure 10

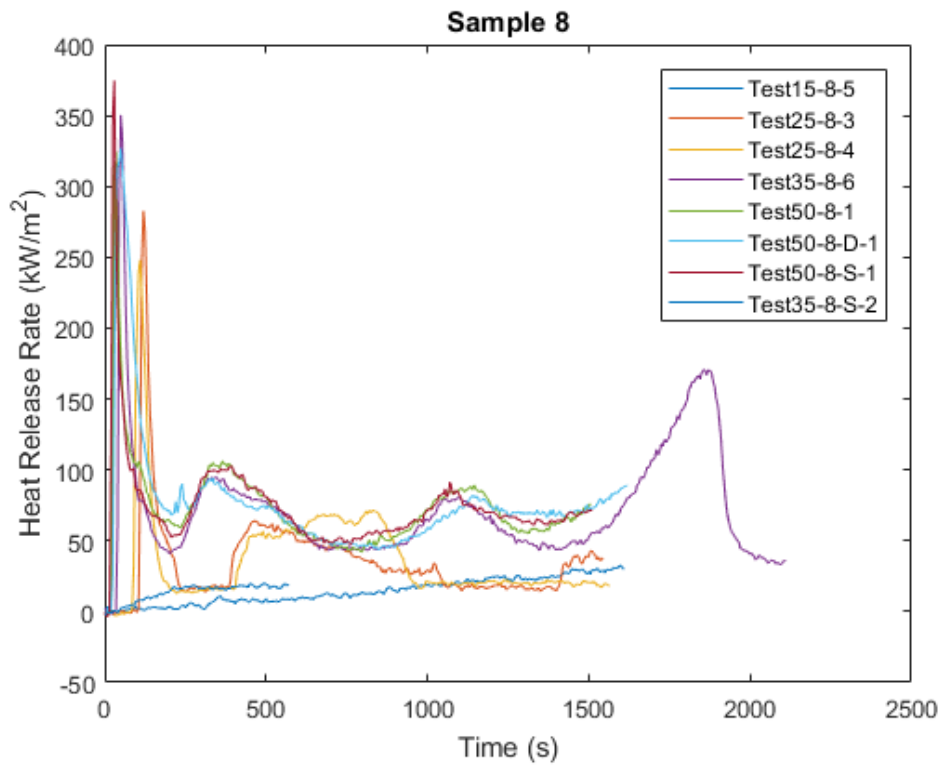

Figure 11

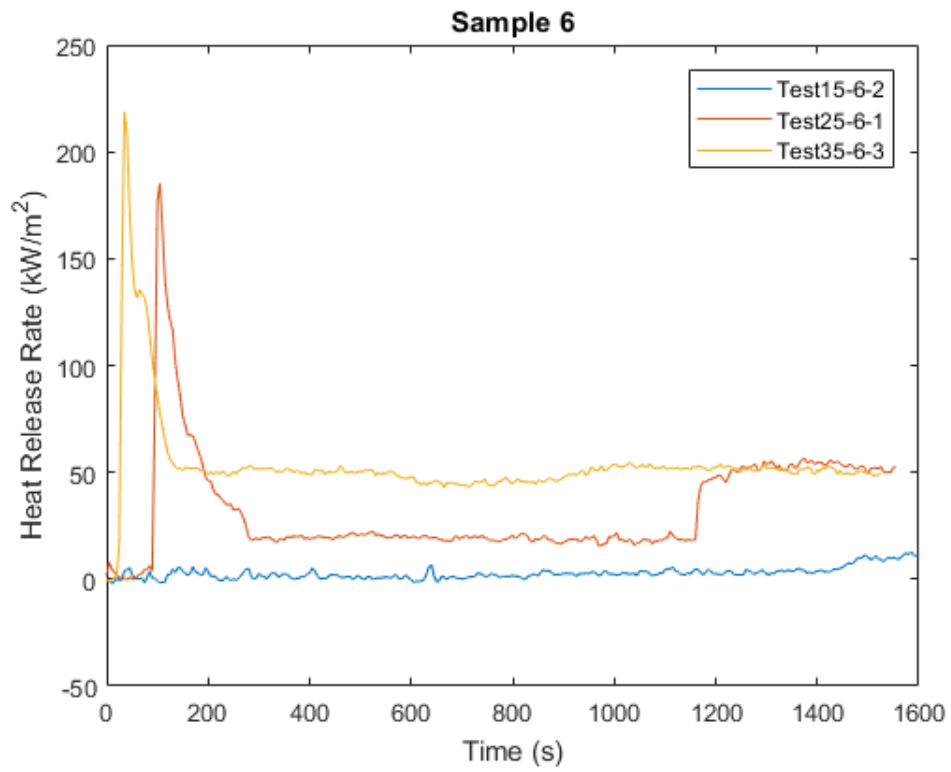

Figure 12

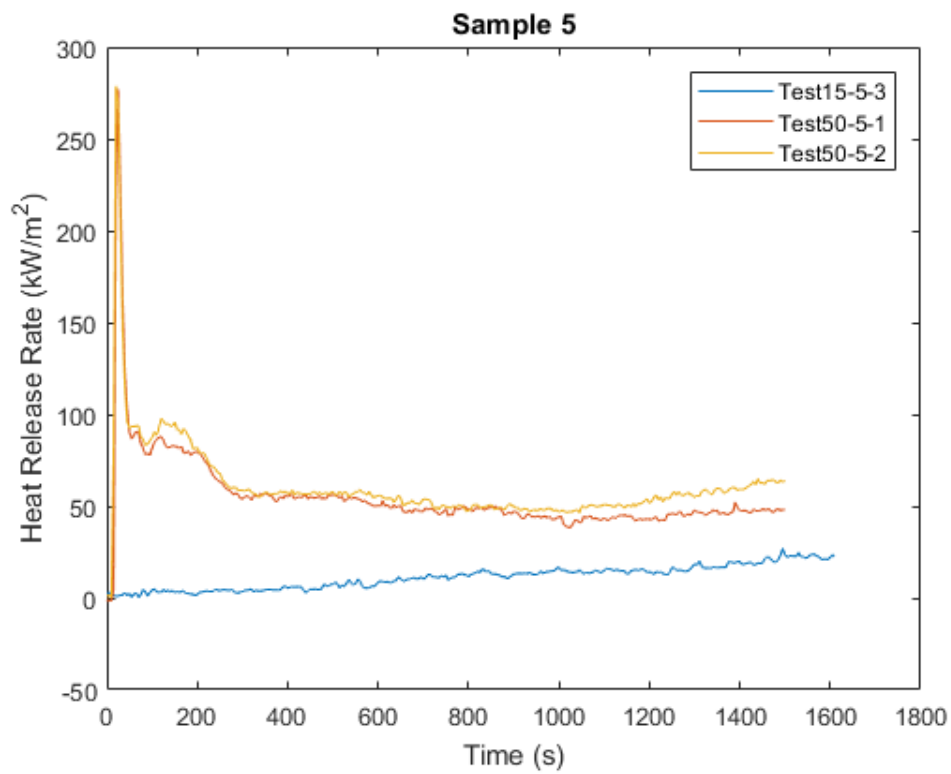

Figure 13

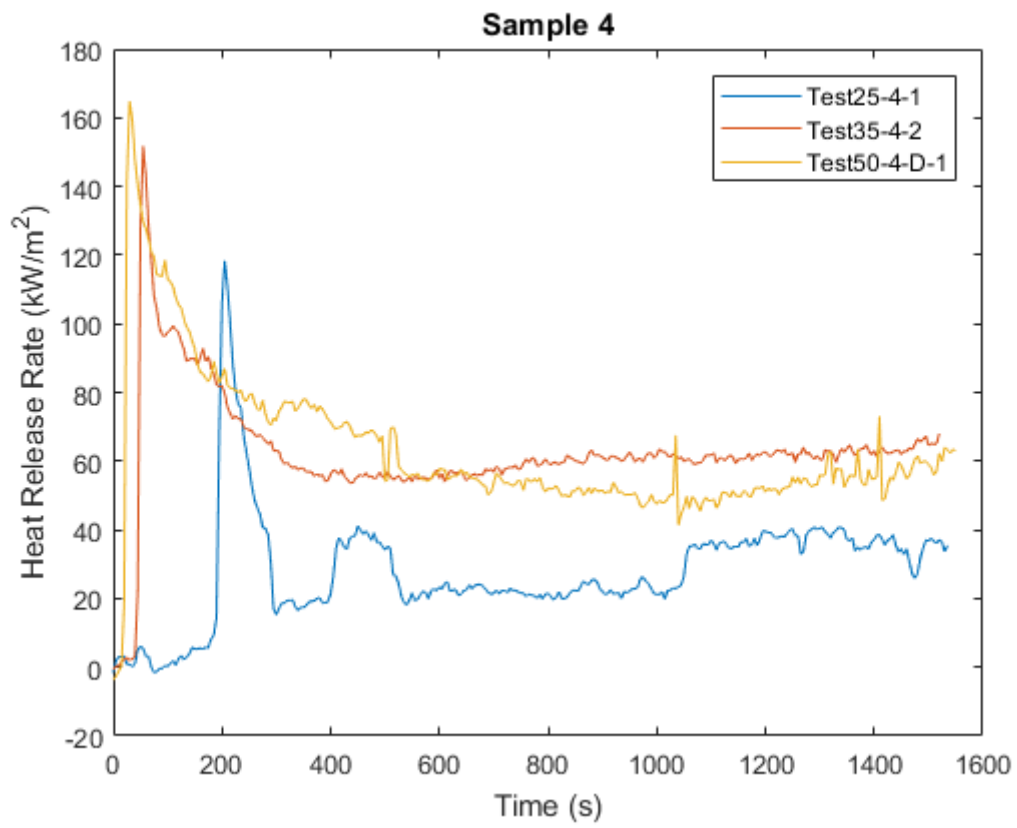

Figure 14

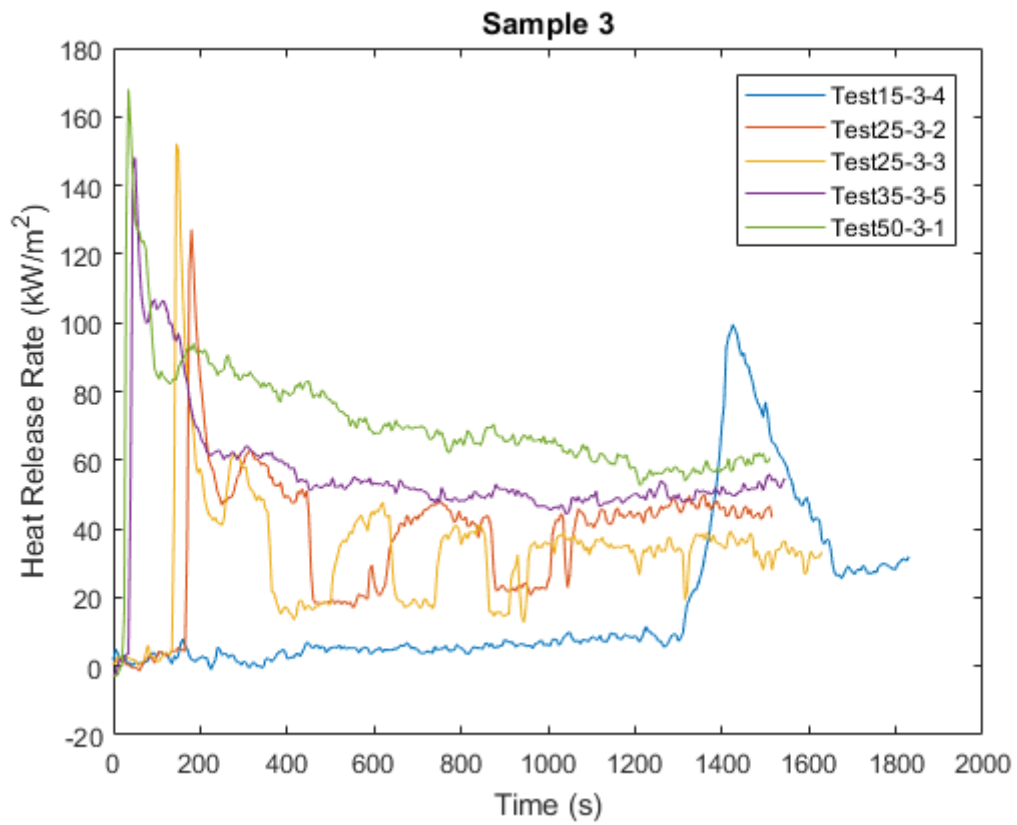

Figure 15

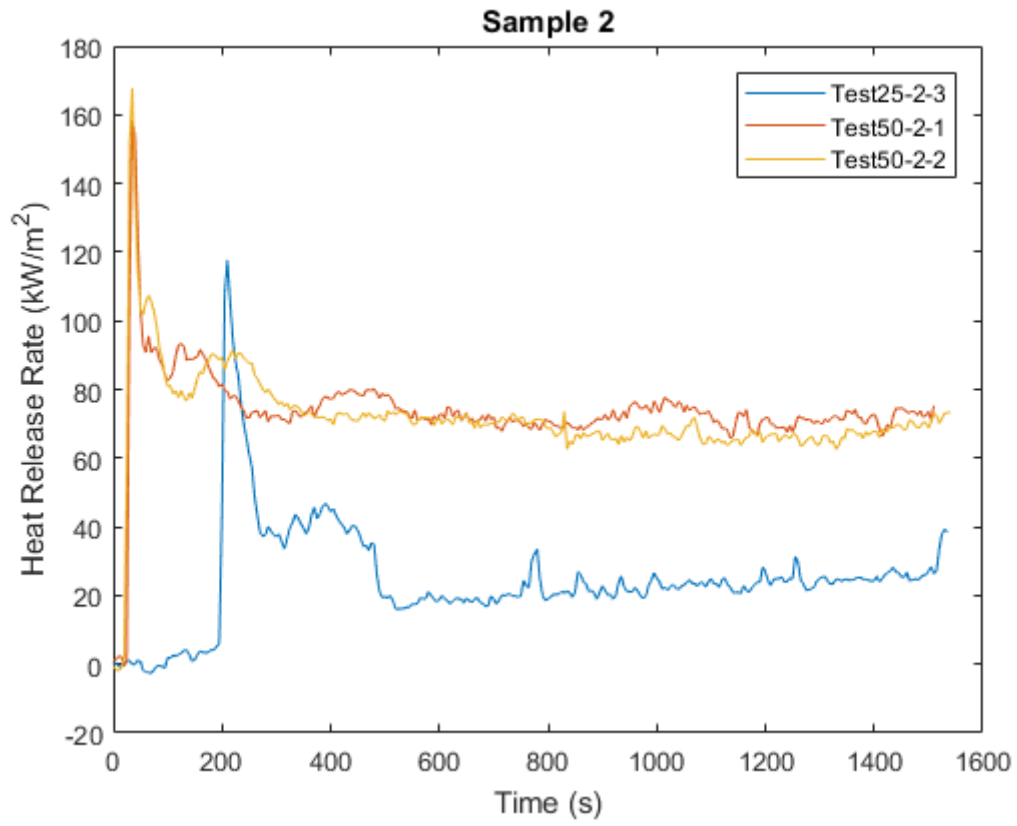

Figure 16

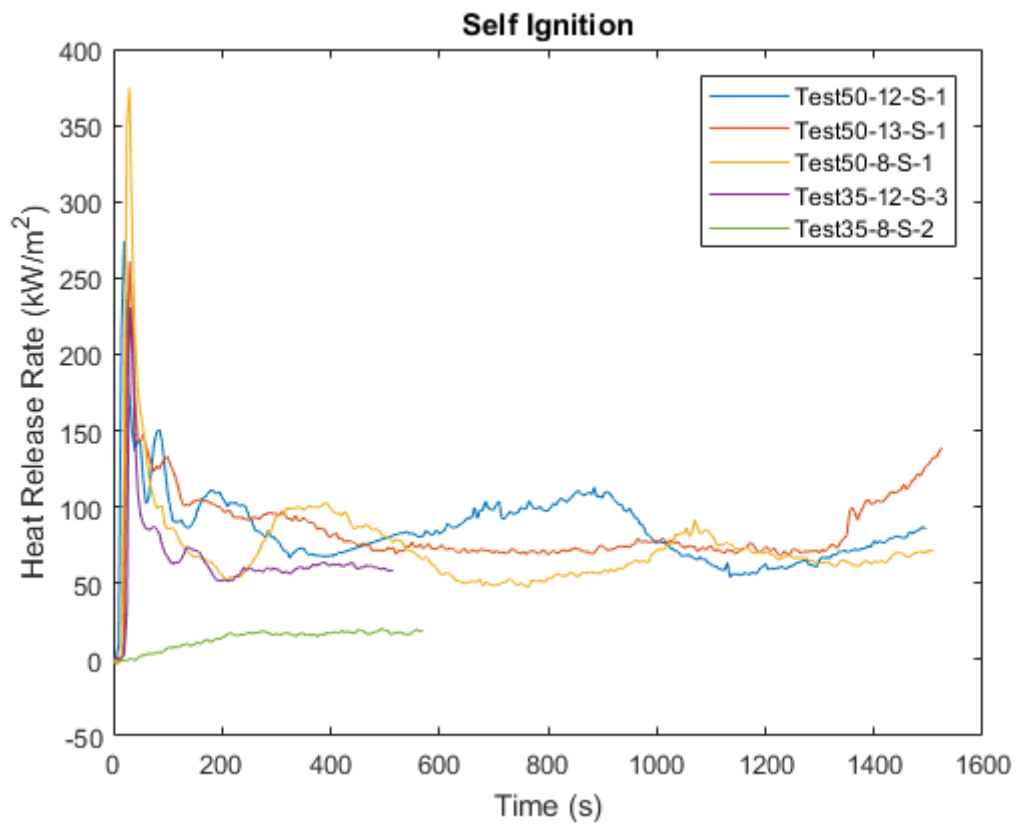

Figure 17

1.4.2 Peak Heat Release Rates

Peak HRR are outlined below from all samples, this is done to highlight the significant variation observed in the sample performance.

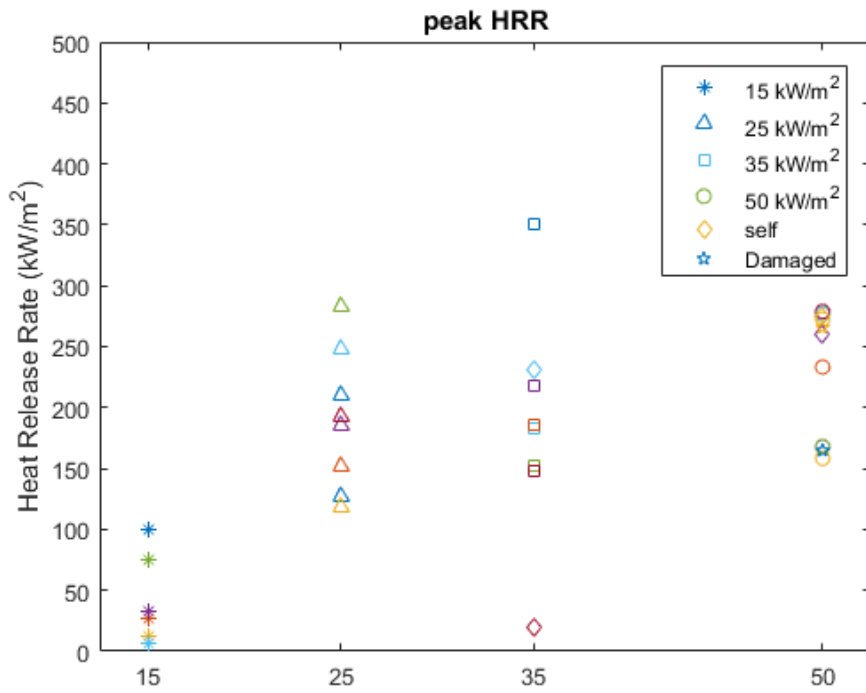

Figure 18

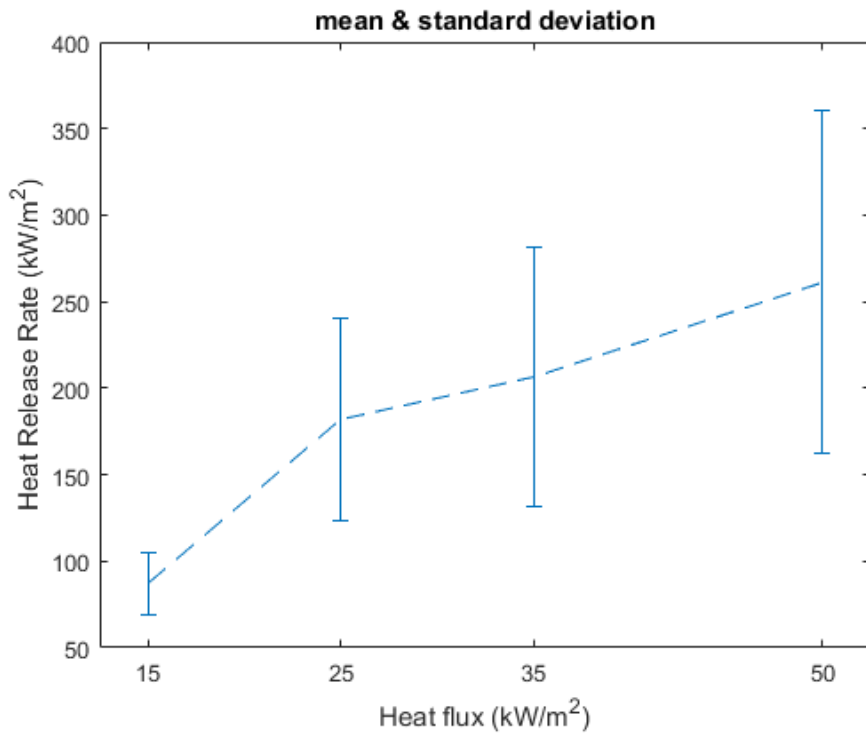

Figure 19

1.4.3 Ignition propensity

Figures below only provide an overall summary of the results for investigating ignition times and the calculation of critical heat flux. However due to the large spread in results due to the significant differences found in the materials. Thus this analysis is performed for individual samples, the results show that some sample will ignite much easier than others.

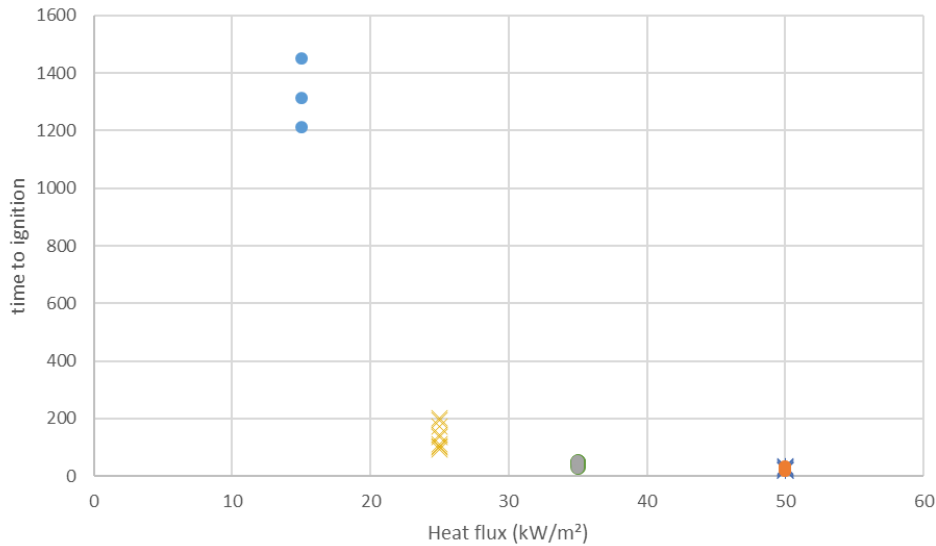

Figure 20

Critical heat flux

Figures 21 and 22 show difference between using linear trendline and polynomial, prediction using the polynomial is more in line with what may be expected based on previous literature.

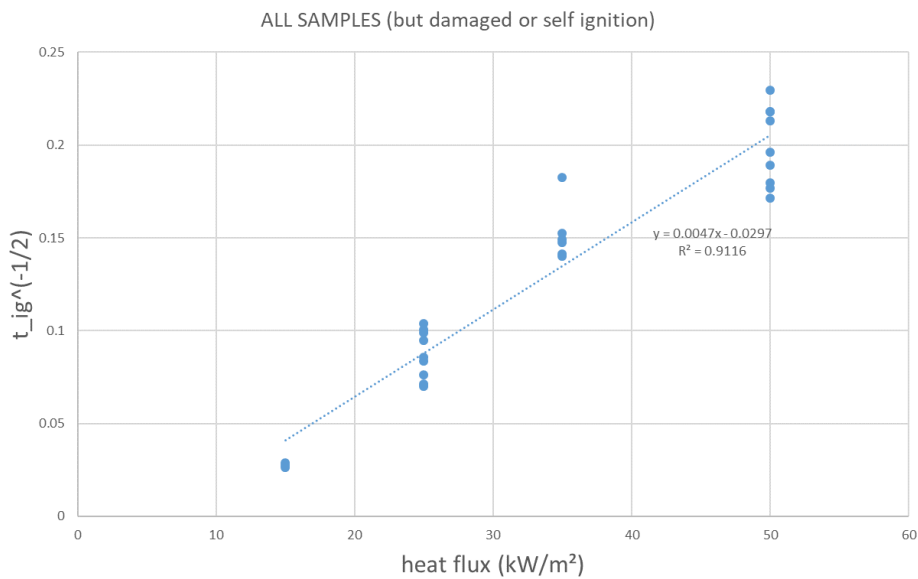

Figure 21

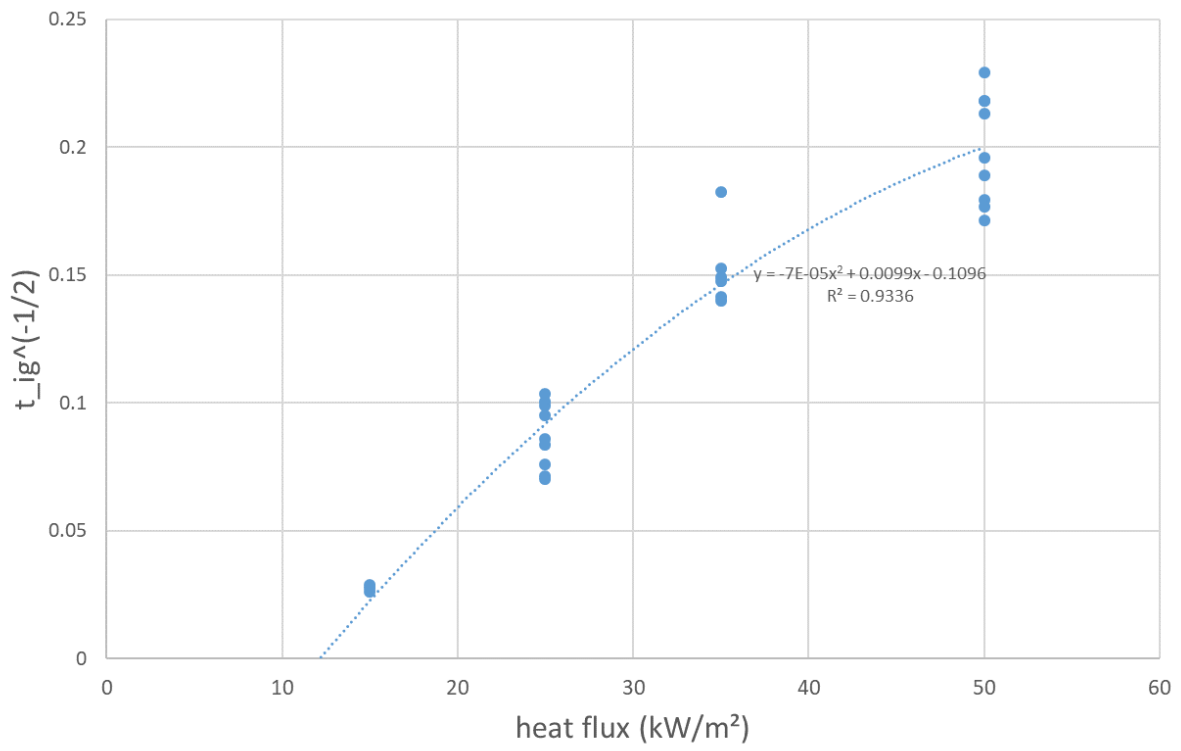
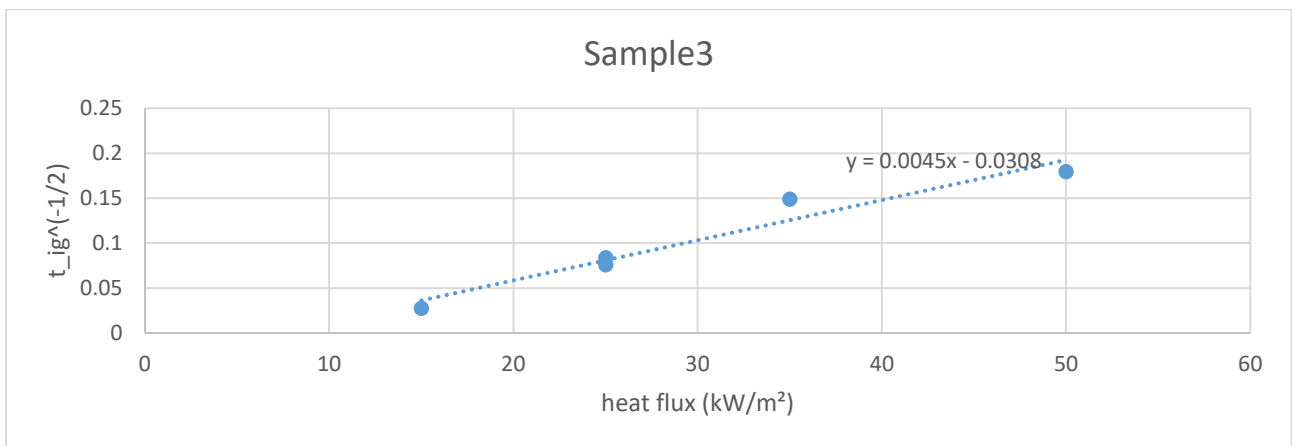
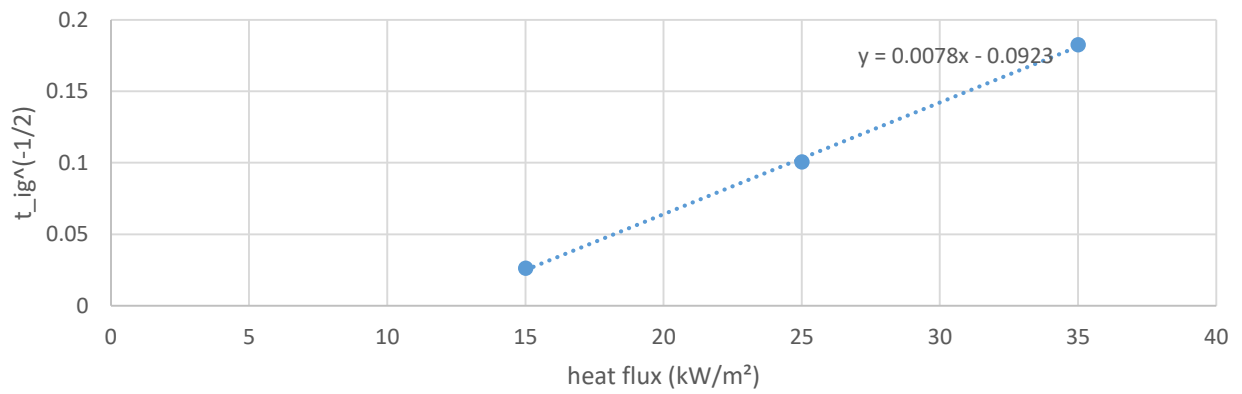

Figure 22

Individual results



Sample6



Sample12

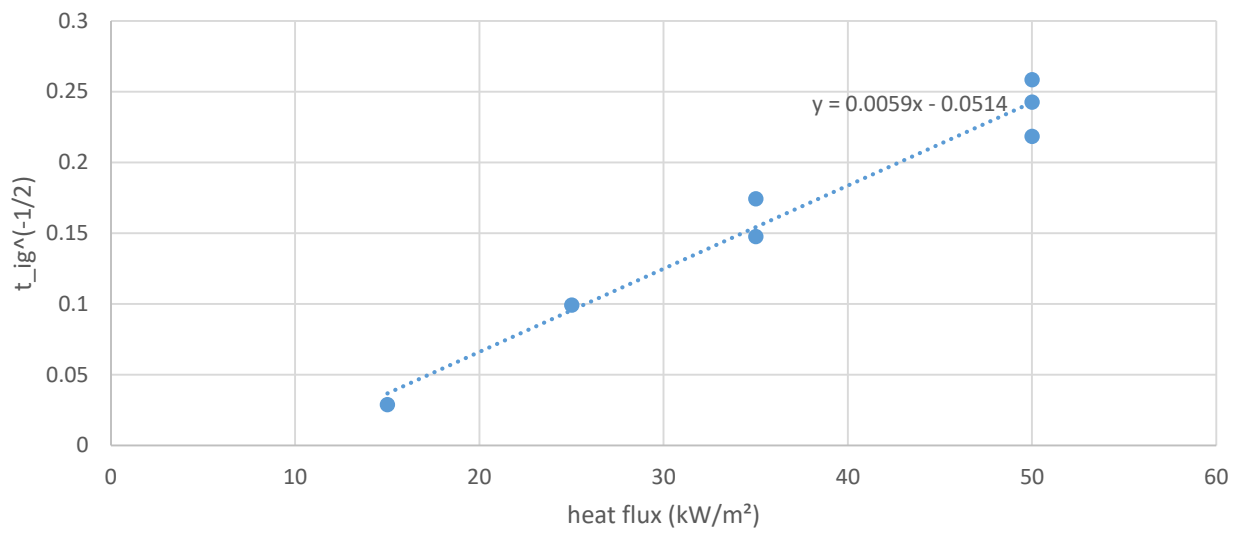

Sample4

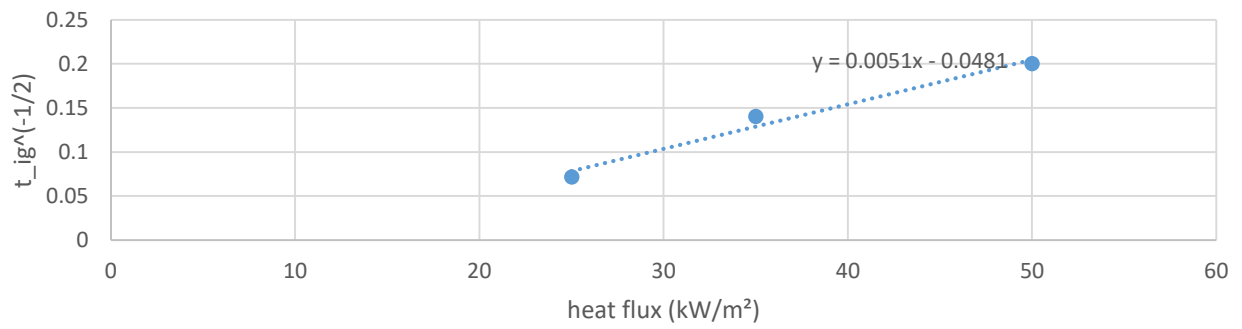

Sample 8

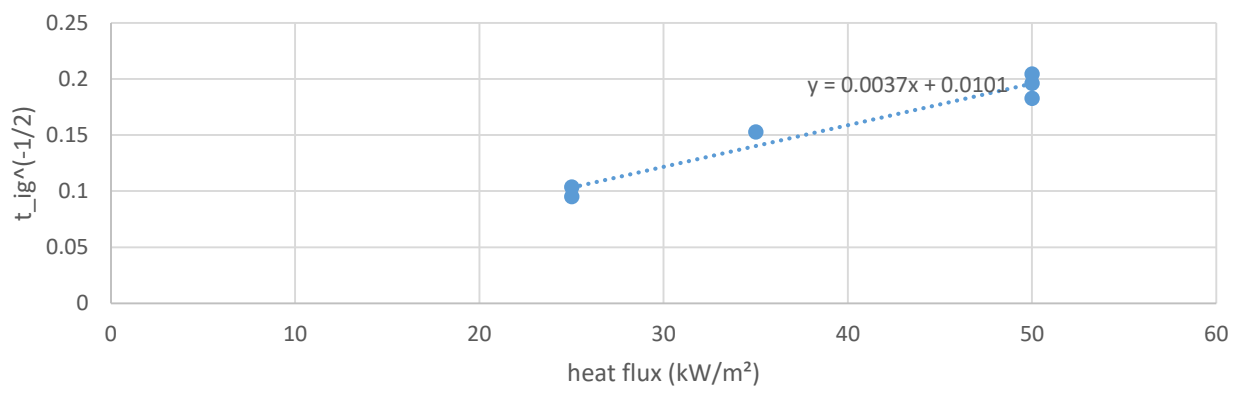

APPENDIX A

Mobile Furnace tests

A.1 Introduction

This small scale fire test's primary focus is to investigate a part of a container flooring exposed to radiation from a steel plate. This setup aims to simulate a section of a container standing on top of another. ISO container is designed to carry all weight at the corner posts, and the corner castings are the only contact surfaces of stacked containers. A 50 mm gap is allowed between one container's top and the lowest part of an adjacent container's bottom structure. The bottom flooring structure is made of a steel frame and steel crossbeams boarded with 28 mm plywood plates. The underside is coated with bitumen to hinder the steel from corrosion and the wood from decay. Bitumen is a semi-solid form of petroleum and known to be flammable.

A.2 The Mobile Furnace

The Mobile Furnace is designed for conducting small scale resistance to fire type experiments. It is electrical heated and equipped for continuous sampling of surface temperatures, furnace temperature and running settings of the automatic furnace controls. Temperatures are sampled with approximately 0.8 Hz.

The Mobile Furnace is a "development furnace" and the results in their form and presentation may be subjected subsequent changes. Possible modification of the furnace itself is expected and hence of the tests outcome, with streamlining on the measurement technique and on the control of the furnace. Figure A.1 illustrates the test furnace.



Figure A.1: The Mobile Furnace

A.3 Test Setup

Figure A.2a and A.2b show the test sample cut from the container bottom and figure A.2c shows the sample of the top plate.

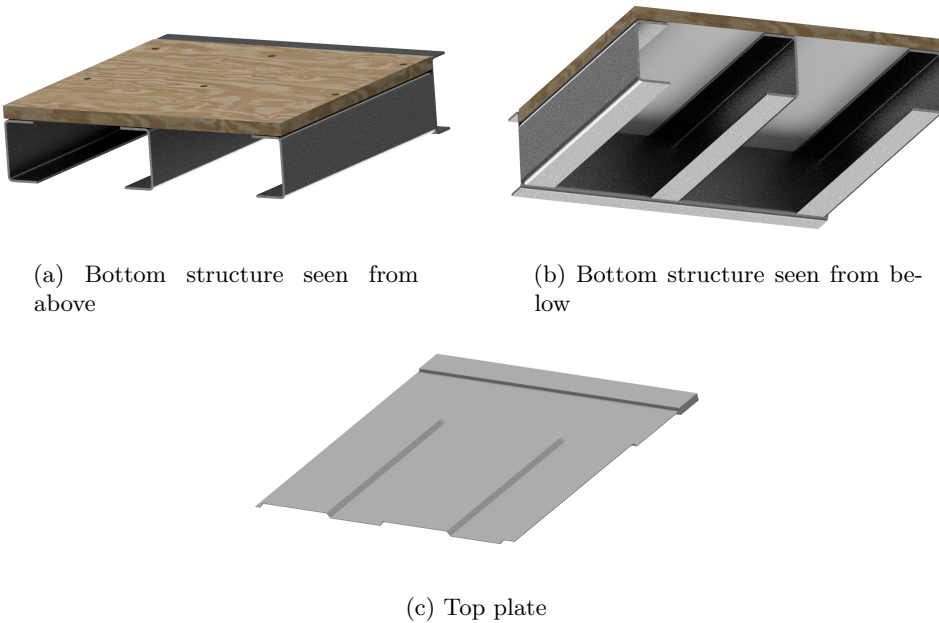

(a) Bottom structure seen from above

(b) Bottom structure seen from below

(c) Top plate

Figure A.2: Illustration of the test parts

The experiment was performed in DBI laboratory, using a furnace adapted for

small scale set-ups. The top plate (fig. A.2c) was placed on top of the furnace, covering the furnace chamber and the bottom piece was mounted on top, allowing the 50 mm gap in-between them. Instead of using the main thermocouples inside the furnace for heat control, three thermocouples were welded on the top plate's unexposed side as a control instrument, such that the top plate could act as the heat exposure. The controlling temperature was set to $620\text{ }^{\circ}\text{C}$ with a warm-up time of 20 minutes. As shown in figure A.3, a steel lid was welded on the sample to close the opening, and the exterior sides were insulated with mineral wool in order to avoid heat losses.

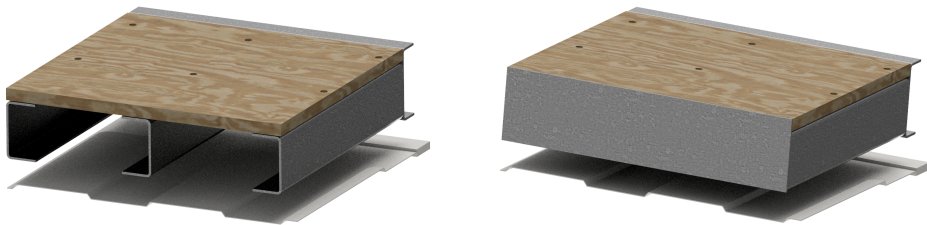

(a) Bottom structure without lid

(b) Bottom structure with lid



(c) Isolated test sample

Figure A.3: Test sample with rock wool isolation

As shown in figures A.4a and A.4b, eight TC were mounted on the sample for temperature reading, five covered with pads and glued to the unexposed surface, and three in the components' cavity, one through a drilled hole, one hanging, and one placed between the mid beam and the plywood. A thermal camera was used for recording the heat distribution on the plywood unexposed side (the camera was mounted with a delay of 5 minutes, with respect to the test start).

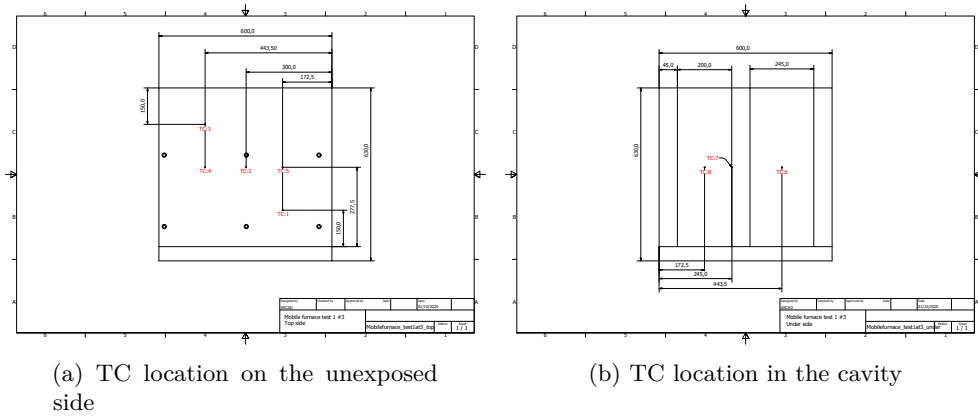

Figure A.4: TC setup on the test sample, a full size version can be found at the end of this report

A.4 Automatic control

The test was run with automatic control of the heating. The operator only placed the test specimens on the furnace, scooted the bottom chamber division out, and pressed start in the software. No intervention was done after this, and the full tests were done without any human interaction. At the end, the operator finished the test by stopping the measurement and removing the test specimen.

A.5 Testing

This test's primary focus is to replicate fire development between two containers, using a small sample from the container bottom and top plate. The test was run for 100 minutes. Ignition occurred after 23 minutes starting at the surface of the mid beam nearest the exposures. During the first minutes after ignition, the flames were in green, blue color. As figures A.5 A.6 and A.7 show, flames were detected elsewhere in the cavity and at the steel structure, and bitumen dropping on to the exposure plate was observed. The flames in the sample prolonged throughout the test time.



Figure A.5: Flames inside the cavity



Figure A.6: Flames on a steel beam



Figure A.7: Bitumen dropping on to the top plate

As shown in figure A.8, some smoke escaped from the cavity through the plywood and steel frame's junction and this occurred after the insulation material started to melt.



Figure A.8: Smoke at the junction of plywood and steel frame

Figure A.9 shows all temperature measurements during the test and Figure A.9

illustrates the temperature at the exposure. At the unexposed side the temperatures increase uniformly between 20 and 80 minutes and then after increase steeper and not uniformly as shown in figure A.10. The TC located in the cavity increase sharply, and all have reached more than 350 degrees after 20 minutes. The peaking temperatures for TC 6,7 and 8 takes place just after the ignition reaching up to 700 °C.

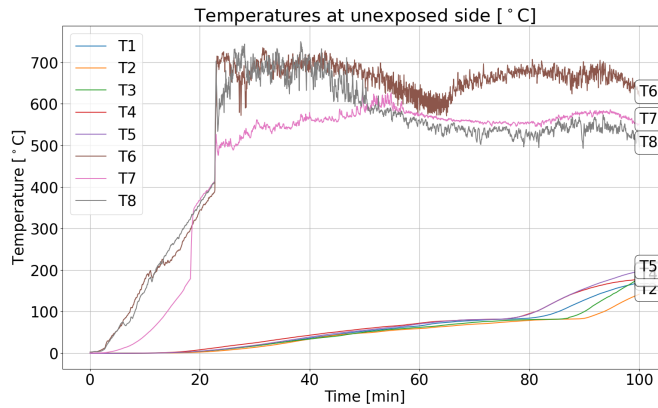

Figure A.9: Temperature measurements

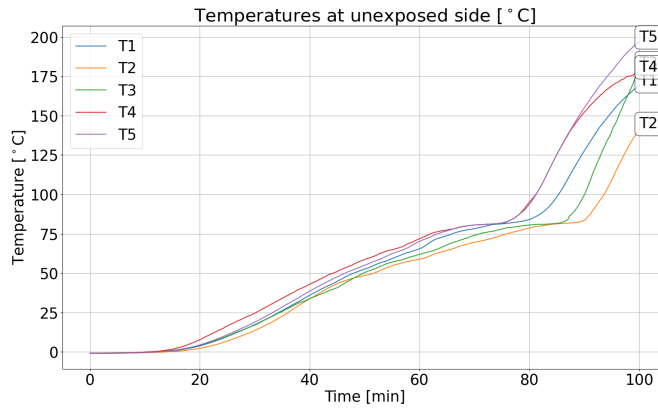

Figure A.10: Temperature measurements at the unexposed side

Figure A.11 is the graph for the air pressure inside the furnace, and as it can be seen, it initially decreased due to deformation of the top plate, affecting the airtightness of the furnace chamber. Mineral wool was stuffed after 10 minutes to fill in

the gaps between the top plate and the furnace surface so as to maintain a positive air pressure.

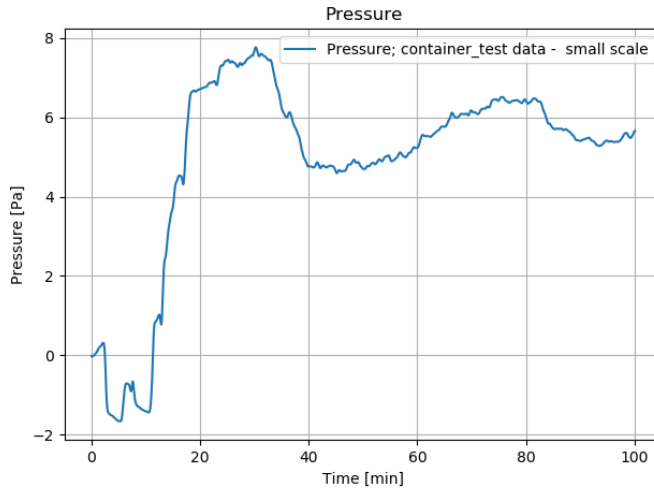

Figure A.11: Chamber pressure

A.6 Examine of sample after test

After the test was stopped, the sample was removed outside for cooling and suppressing fire. It was noticed that little or nothing of the charred plywood had fallen to the top plate. The remains of the plywood came off from the steel frame rather easily. As figure A.12 shows, approximately 1/4 of the plywood has burned through at the left side. And can partly be explained by a not sufficiently isolated gap between the lid and the plywood. No deformations were notched on the steel frame.



Figure A.12: The test sample after the test

After scraping the loose charred lay off the unburnt plywood the remaining layers of the plywood was measured to be approximately 6.5 mm as shown in figure A.13b.



(a) Plywood after test cut in half



(b) Thickness measurements

Figure A.13: Examination of the plywood after test

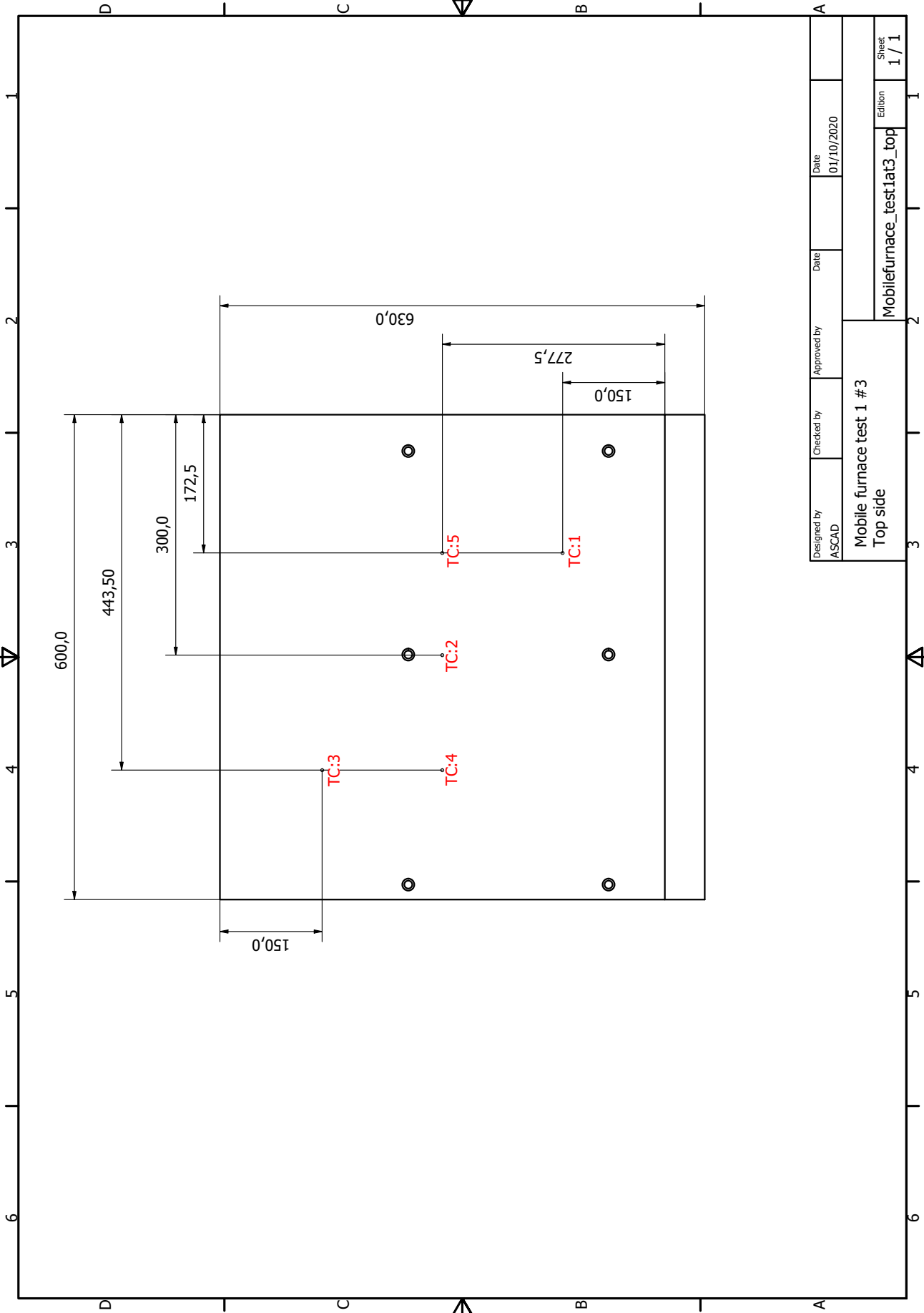

Designed by ASCAD	Checked by	Approved by	Date 01/10/2020
Mobile furnace test 1 #3 Top side			Edition 1 / 1
Mobilefurnace_test1at3_top			

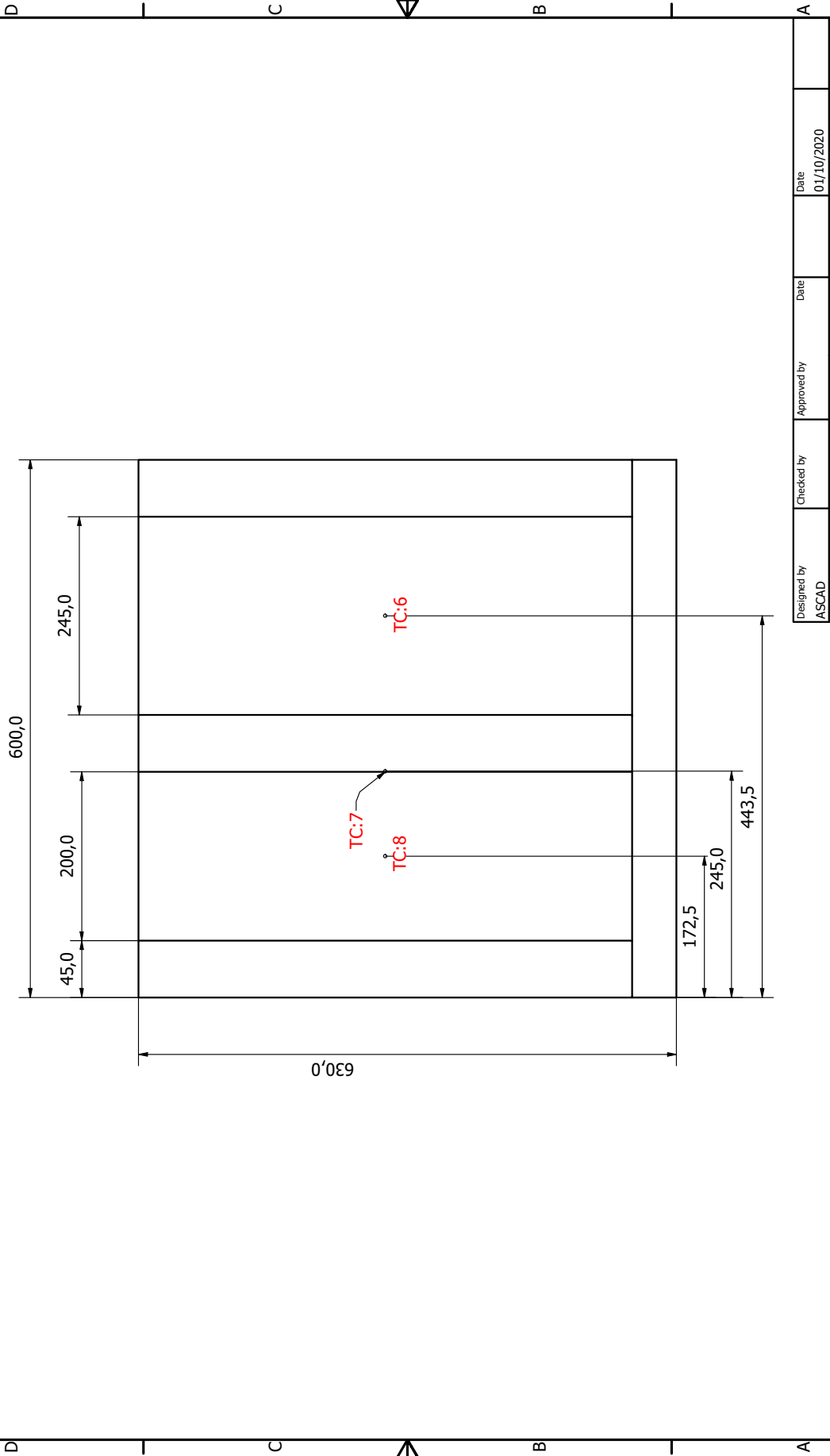

Designed by ASCAD	Checked by	Approved by	Date 01/10/2020
Mobile furnace test 1 #3 Under side			Edition 1 / 1

APPENDIX B

Full Scale Test

B.1 Introduction

This full-scale fire test is part of a series of fire tests, where different elements of a 20-foot container are tested with the primary focus to gain knowledge of the container integrity when exposed to fire.

The purpose with this full scale fire test is to examine a container door section exposed to high temperatures. The test was carried out 22-09-2020 at DBI- The Danish Institute of Fire and Security Technology testing facilities.

B.2 Test Setup

In this full scale test a part of the container, including the door leaves and frame, was cut off from a 20-foot seaworthy container¹ and placed in a designed test frame as shown in figure B.2. The test frame was constructed with aerated concrete with a hole slightly bigger than the dimensions of the door section. The door section was mounted in the test frame and screwed fast through the concrete, the surrounding gap between the container and the concrete was isolated with rock wool and ceramic wool as illustrated in figure B.2b. The remaining of the plywood flooring in the container part was removed and gaps between the steel cross members isolated to avoid heat loss as shown in figures B.1b. The test frame was then mounted vertically on front of a 3x3 m full-scale fire test furnace. The test was run for approximately 90 minutes and the furnace temperature set to follow the iso 834 standard fire curve. Thermocouples and infra red camera were used for temperature measures on the unexposed surfaces and as well deflection and heat flux was measured.

¹container has been inspected by a maritime surveyor and can be used to ship goods/products overseas



(a) Door section before mounting in to the test frame



(b) Door section after being mounted in test frame

Figure B.1: Installation of the door section to the test frame



(a) Isolation of the gap between container and aerated concrete



(b) Isolation between the cross members after removing plywood flooring

Figure B.2: Door section after being mounted in test frame

B.3 Temperature Measurements

Figure B.3 shows the locations of the temperature measurements on the test sample. Five groups of thermocouples (TC) located similarly as for standard test of a double door except the TC group number 4 which was placed on the sides of the door frame. TC "group 1" was mounted on the panel of each door leaf, "group 2" on the door header and door sill, "groups A3 and B3" where located at the left and right door rails respectively.

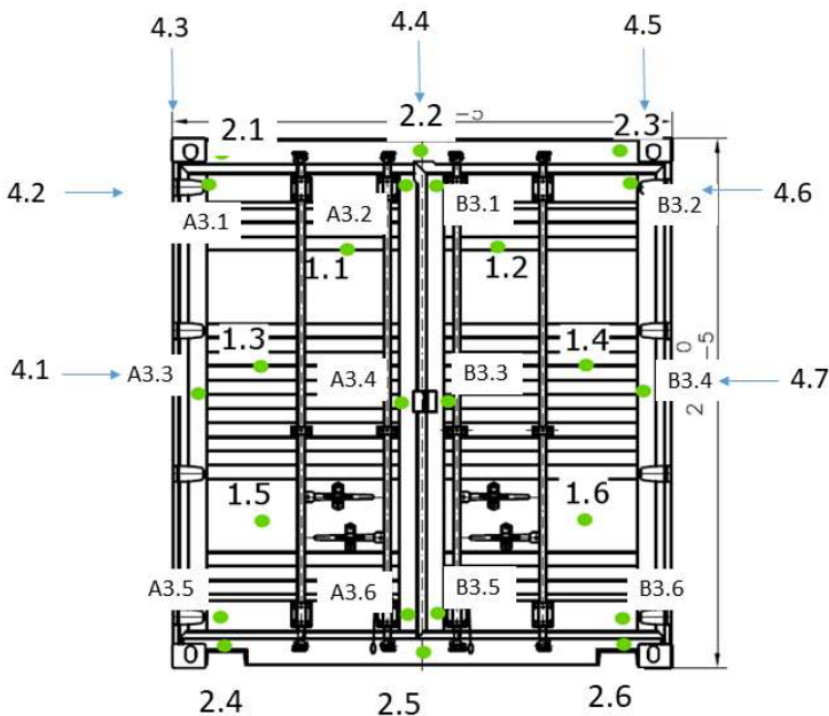
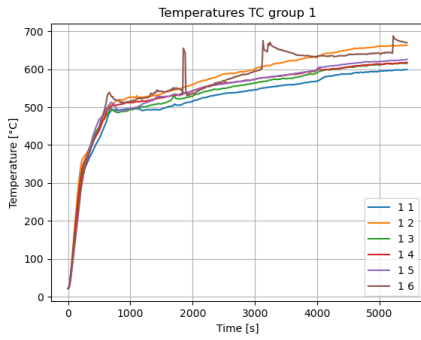
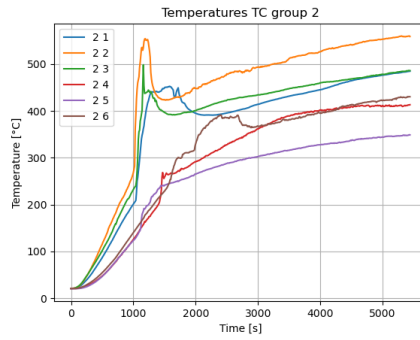

Figure B.3: Locations of deflection measuring points on the door section. Dimensions of TC can be found in the end of this report

The temperatures increased fast during the first minutes of the test, and after approximately 17 minutes, the door gasket caught fire. From figures B.4a, B.4b, B.4c and B.4d it can be seen that the flames were touching the TC and causing the disturbance of the temperature curves during the time interval between 1000 and 2000 seconds. After that, most of the rubber seal was burned off, and the temperature increased more uniformly throughout the remaining of the test period. Signal to TC "B3-4" was lost during the test as can be seen from the flat curve in figure B.4d.



(a) Temperatures for TC group 1 at the panel of the door leafs



(b) Temperatures for TC group 2 at the container header and sill

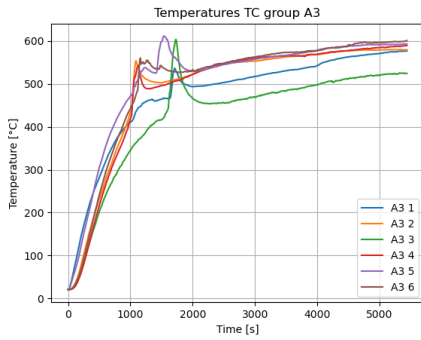

(c) Temperatures for TC group A3 at the left door rails

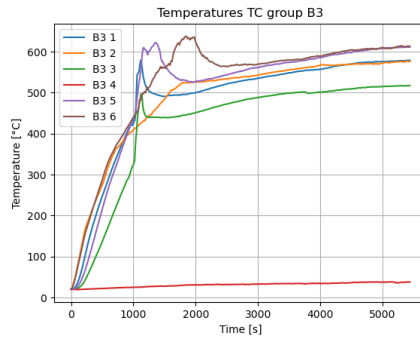

(d) Temperatures for TC group B3 at the right door rails

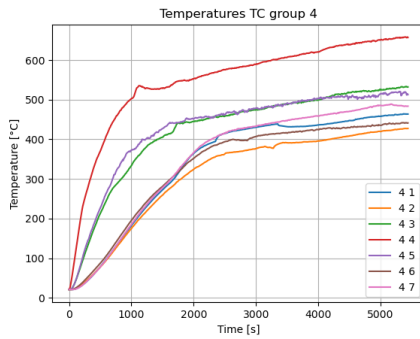

(e) Temperatures for TC group 4 at the side of the container

Figure B.4: Temperature measurements of the test sample

Figure B.5 shows the maximum temperature reading taken from each TC group. The highest temperature reading is found to be at "TC 1.6" placed far down at the panel of the right door leaf. The lowest maximum temperature is at "TC 2.2" placed in the middle of the door header.

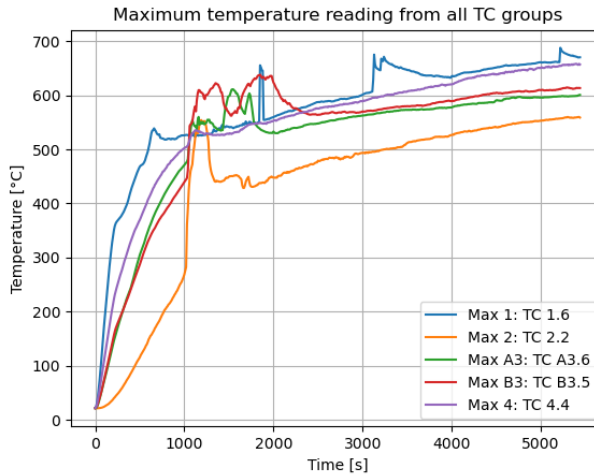

Figure B.5: Maximum temperatures from each TC group plotted to gather

Thermocouple	Max Temperature
TC 1.6	687 °C
TC 2.2	560 °C
TC A3.6	611 °C
TC B3.5	638 °C
TC 4.4	658 °C

Table B.1: Values of maximum temperatures, corresponding to figure B.5

B.4 Deflection Measurement

In the following section figures are shown for the deflection measurements with sub-figures of the temperature readings from the nearest TC. Negative number in the deflection measurements stands for the movement into the furnace, and positive numbers represent the movement out from the furnace. The deflection measures were located as listed in figure B.6. The measurement device stands of a detection camera placed from the furnace and deflection couples welded to the unexposed side of the

test specimen. Because of high thermal radiation the detection camera was shut-down and covered after approximately 35 minutes to prevent it for damages, and therefore are the following figure only representing part of the deformation. Usually the greatest deformations of unprotected steel under thermal load occurs during the temperature increase, therefore it can be assumed that the deformation changes have reached uniform behaviour during the rest of the testing time. The time axis on the deflection figures are not equal for all measured points, that is because flames were interfering the signal and some data was cut of in the data processing, interpolation was used to fill in the gaps where data was lost in-between. Deflection measurements points 9, 10, 13, 14 and 17 where totally lost.

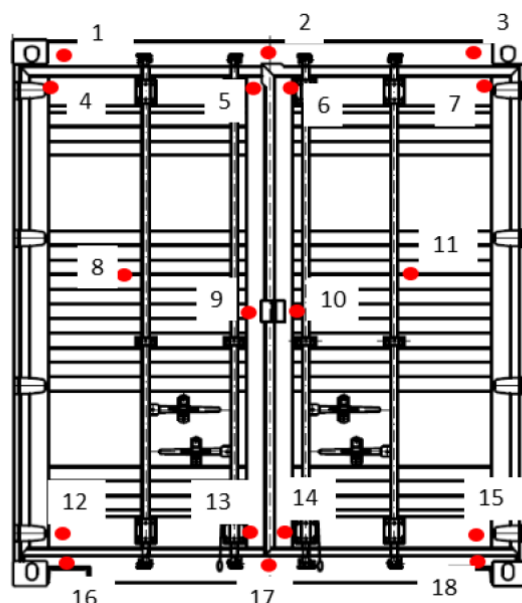
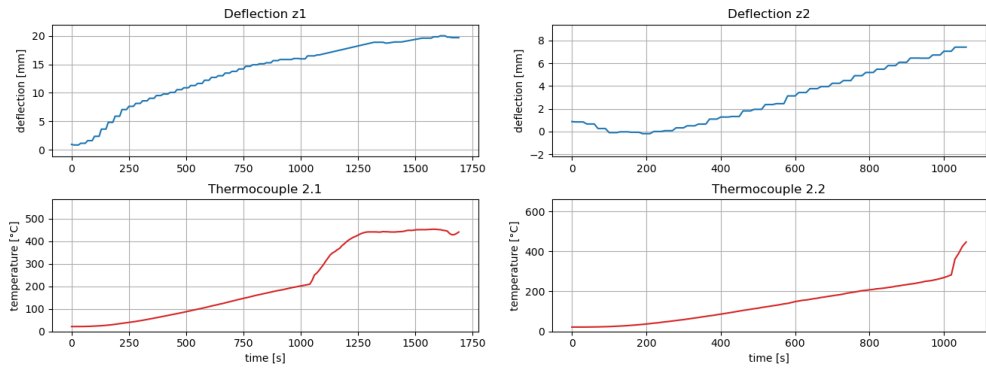

Figure B.6: Locations of deflection measuring points on the door section. Dimensions of deflection measurements can be found in the end of this report

From figure B.7 it can be seen that the top of the door header deforms in positive direction for all three points measured. From figures B.7a and B.7c it can be seen that the deformation occurs more slowly after the temperature reaches 400 °C, because of lack of data this can not be concluded for B.7b but can be assumed.



(a) Deflection point z1 and TC 2.1

(b) Deflection point z2 and TC 2.2

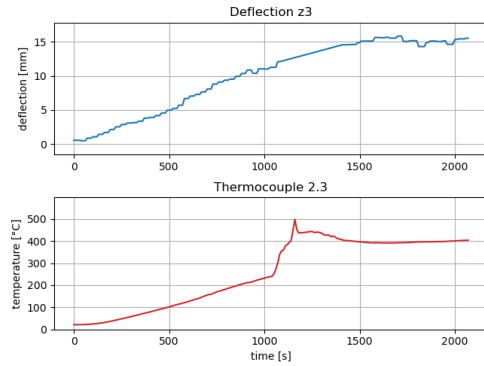

(c) Deflection point z3 and TC 2.3

Figure B.7: Deflection measured at the top of the door header

Figure B.8 shows the deformation of the top door rails for both door leaves. It can be seen in figures B.8a and B.8b that the outer corners of each door leaf are deforming similarly as the door header described in figure B.7. Figures B.8c and B.8d show the deformation of the inner corners of each door leaf which are bending inside the furnace as the temperatures approach 400 °C and there after starts to move externally in the positive direction.

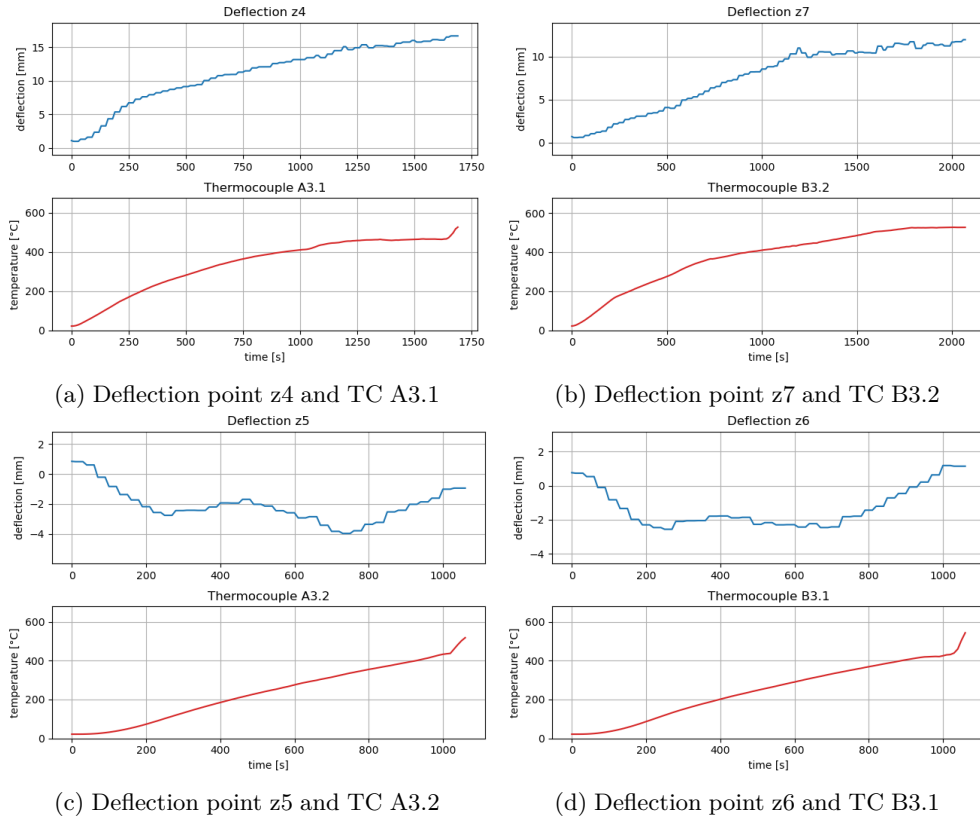
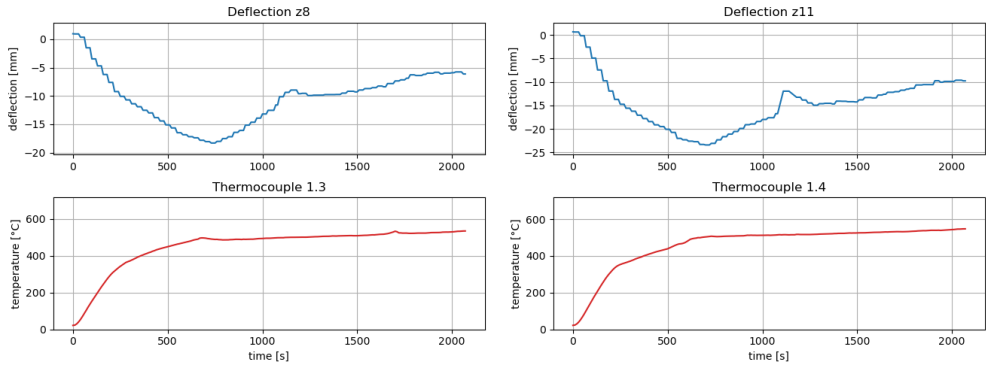

Figure B.8: Deflection measure at the upper door rails

The deflection at the middle of each door leaf panel are shown in figures B.9a and B.9b where the motion behaves similarly to the inner corners as described in figure B.8 above.



(a) Deflection point z8 and TC 1.4

(b) Deflection point z11 and TC 1.6

Figure B.9: Deflection measured at the panel in middle of each door leaf

Figure B.10 shows the deflection of the bottom door rails, it can be seen that left door rail is moving in positive direction versus the right door rail moves in negative direction but has the tendency to move out again with increased temperatures.

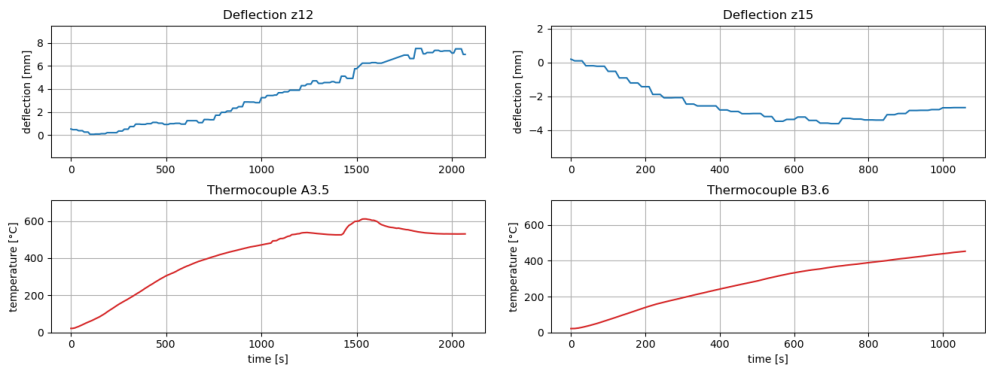

(a) Deflection point z12 and TC A3.5

(b) Deflection point z15 and TC B3.6

Figure B.10: Deflection measured at the lover frame of each door leaf

The deflection off the door sill shows similar displacement as adjacent measuring points in figure B.10

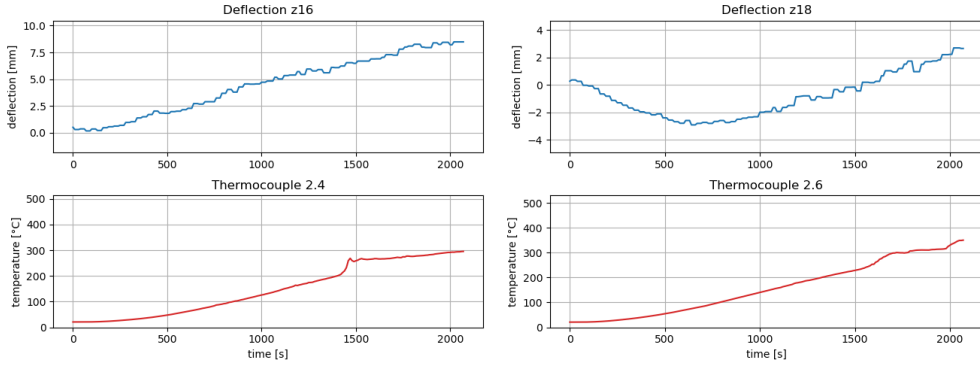

(a) Deflection point z16 and TC 2.4

(b) Deflection point z18 and TC 2.6

Figure B.11: Deflection measured at the door sill

From the deflection measurements above it can be seen that most of the deformation occurs from the initial temperature to approximately 400 °C which is the interval where the temperature increases the most. It is impossible to tell from the measures if deflection would be more stable with increased temperature after the cameras were shut off, but it can be assumed with respect to normal characteristics of steel under thermal load. Figure B.12 shows the thermal radiation measurements at the door leafs junction taken 100 cm from the unexposed surface.

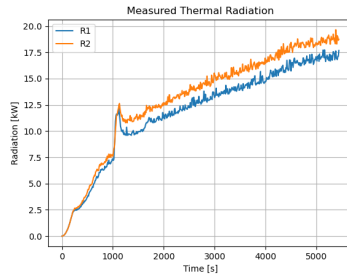

Figure B.12: Radiation measured at the middle of the door section

Measuring points R1 and R2 were located respectively in the height of 185 cm and 102 cm above the container level. Also it can be seen that the radiation increases as the temperature increases and the jump in the graph shows the radiation during the time of fire, the heat flux measures R2 are showing higher values during the test time with the maximum value of 19.66 kW compare to maximum value for R1 at 17.74 kW

B.5 Examine of sample after test

An examination of the test material revealed that the deformation had been reversed and the door frame had gained its initial shape. The door gasket was completely burned away leaving 2 cm gap around the door leafs as figure B.13 shows. No cracks, damages or permanent deflection were noticed on the remains, all functioning part such as door hinge and locking bars were in functional shape.



(a) Junction of the door leaves and the header, showing deflection measuring points z_2 , z_5 and z_6



(b) Left lower corner where deflection measuring points z_{12} and z_{16} were located

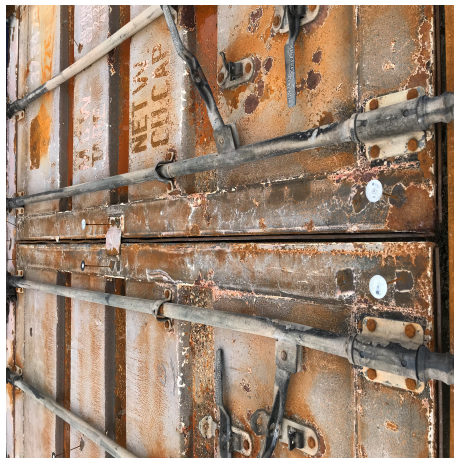

(c) Joint of the door leaves showing z_{13} and z_{14}

Figure B.13: Examination of the door section after test

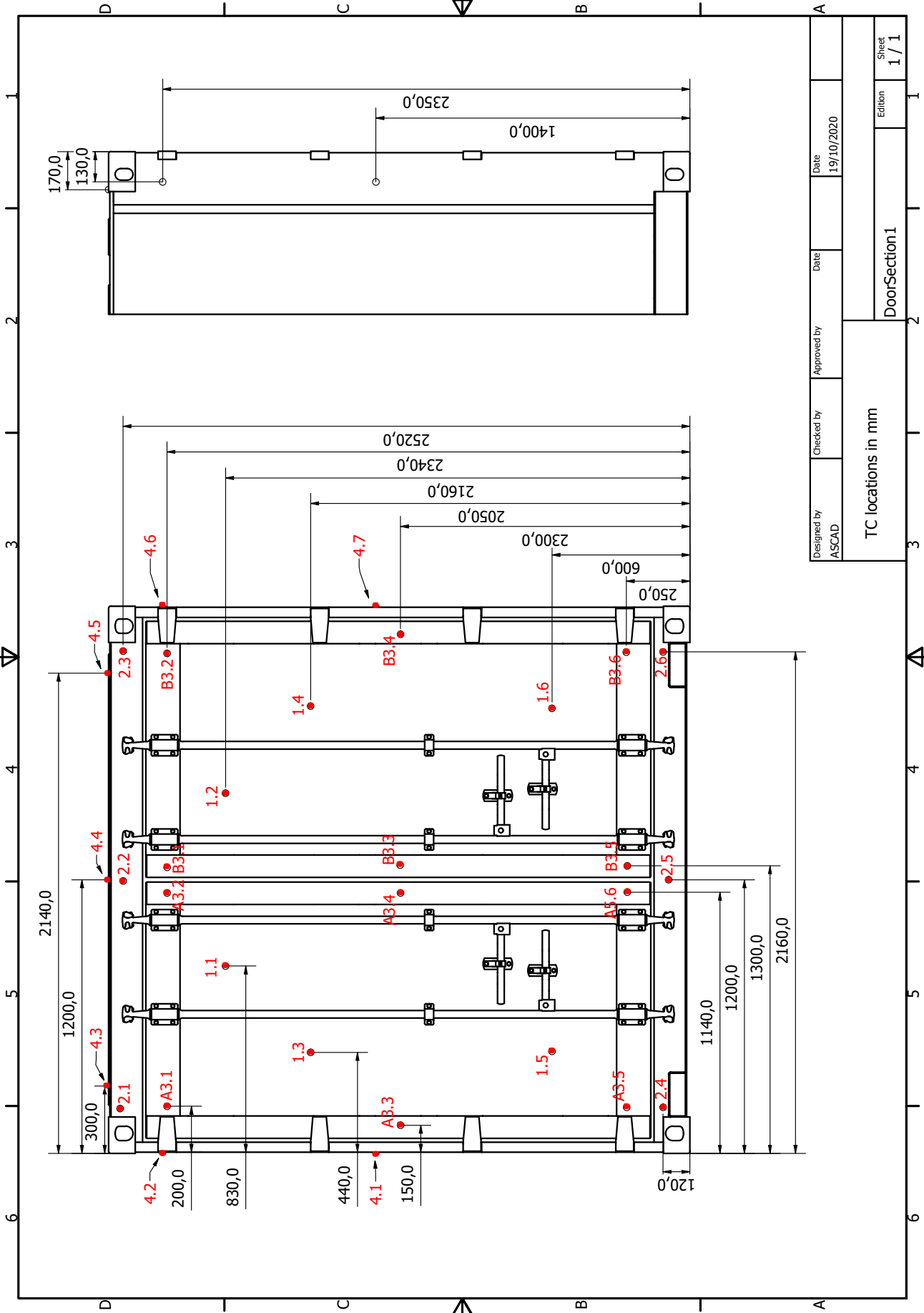

Designed by ASCAD	Checked by	Approved by	Date 19/10/2020
TC locations in mm			DoorSection1
			Sheet 1 / 1

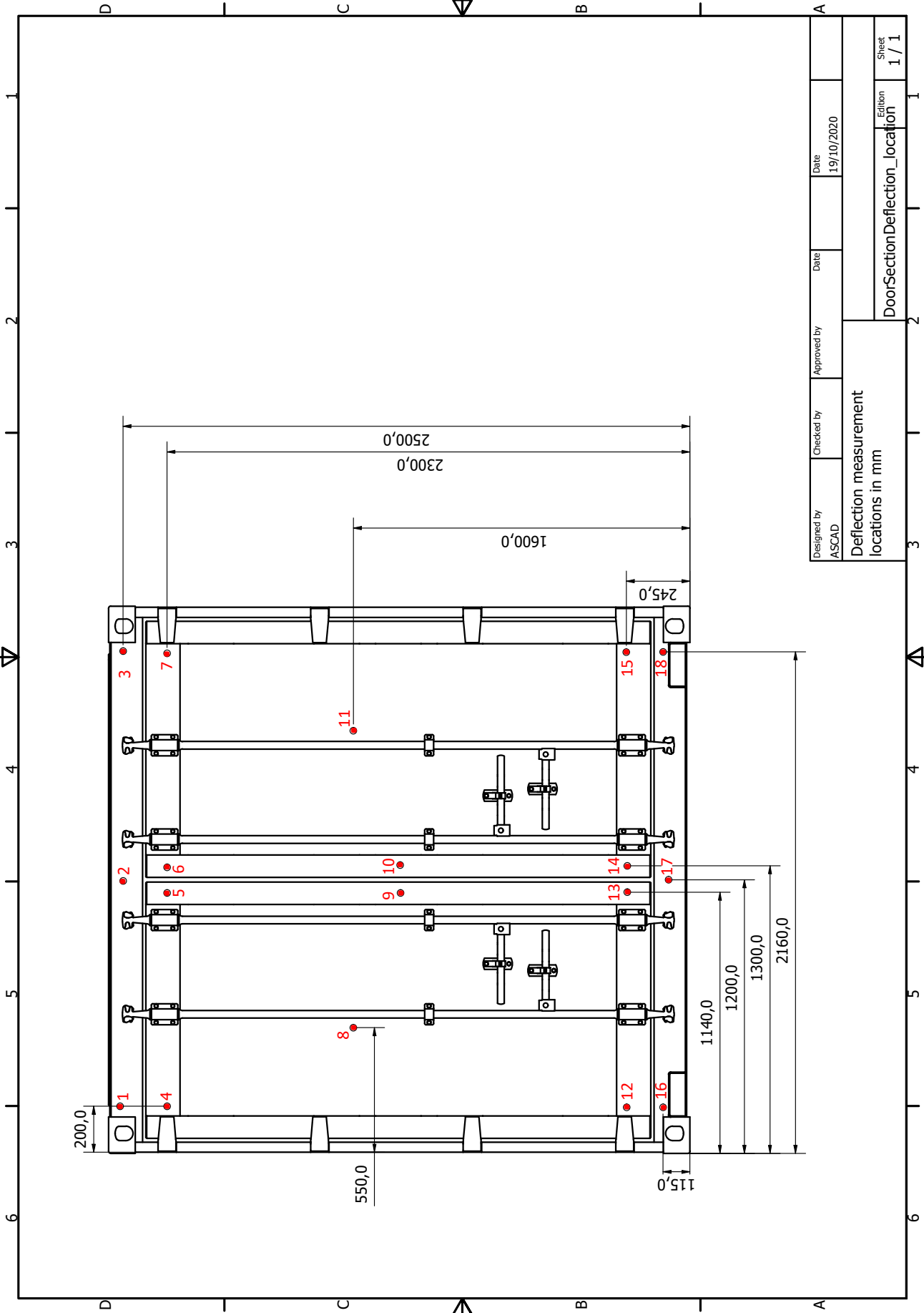

Designed by ASCAD	Checked by	Approved by	Date 19/10/2020
Deflection measurement locations in mm			DoorSectionDeflection_location
			Sheet 1 / 1

Appendix C

Damage map for the container understructure

Following are documentation of the significant damages of the container understructure. Several damages where detected that are evaluated as potential weak points. In the first figure is the overview of the understructure with grid on, that can be useful for deciding locations for cone and mobile furnace tests. The mobile furnace internal dimensions are 500 x 500 mm and the total dimensions are 800 x 800 mm. With respect to the width of the steel structure, the minimum size is for sample is 628 mm so it can lie on top of the furnace.

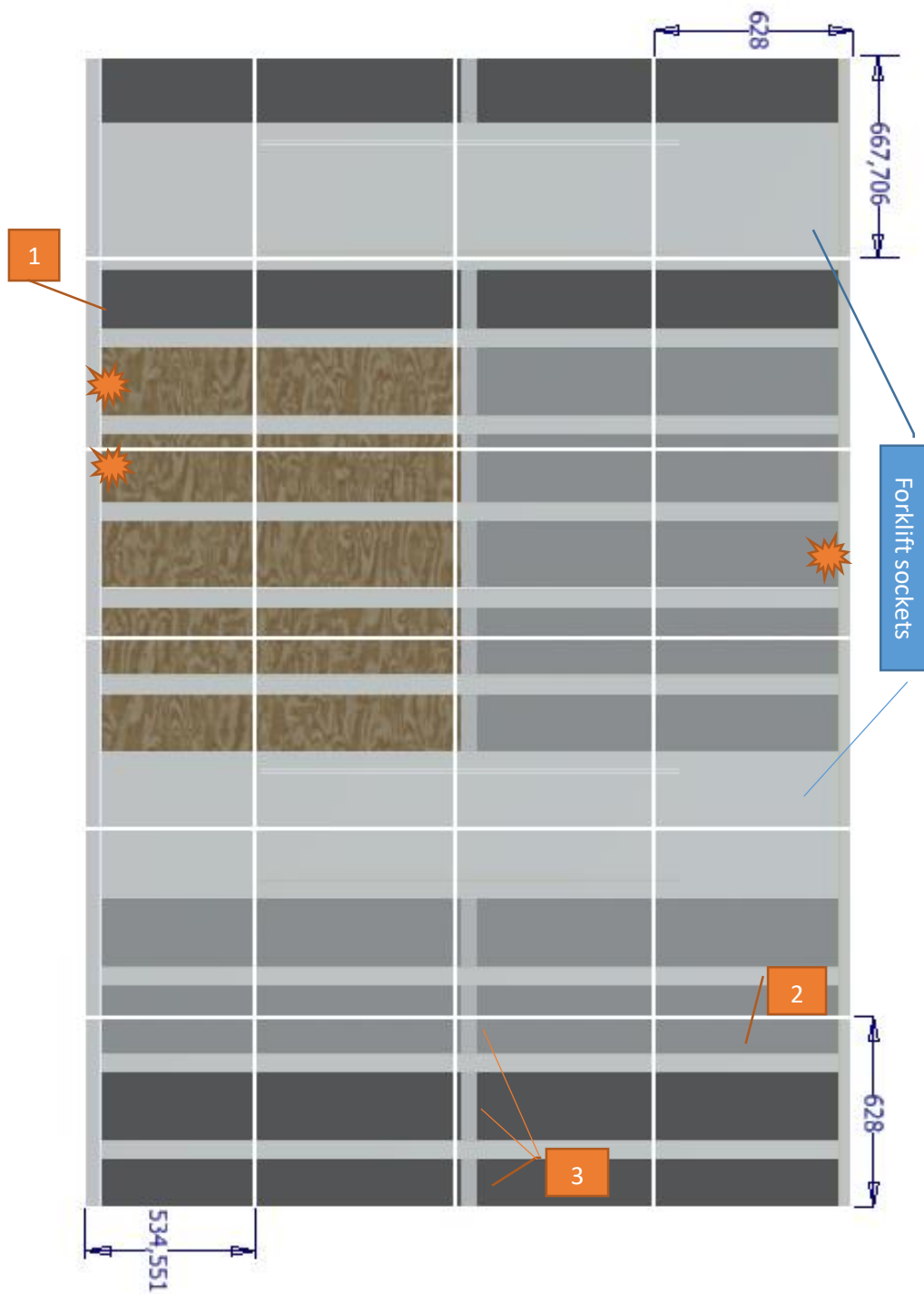

Damage map of the bottom structure seen from beneath

1. Damages bended steel ribbon (see figure "damage1")
 2. Fracture of plywood (see figure "damages2")
 3. Bending's in the middle ribbon (see figure "damages3a and damages3b")
- ☀ Gaping between plywood and steel frame (see figure "gaping1 and gaping2")



damage1



damage2



damage3a



damage3b



gaping1



gaping2



under_bottom

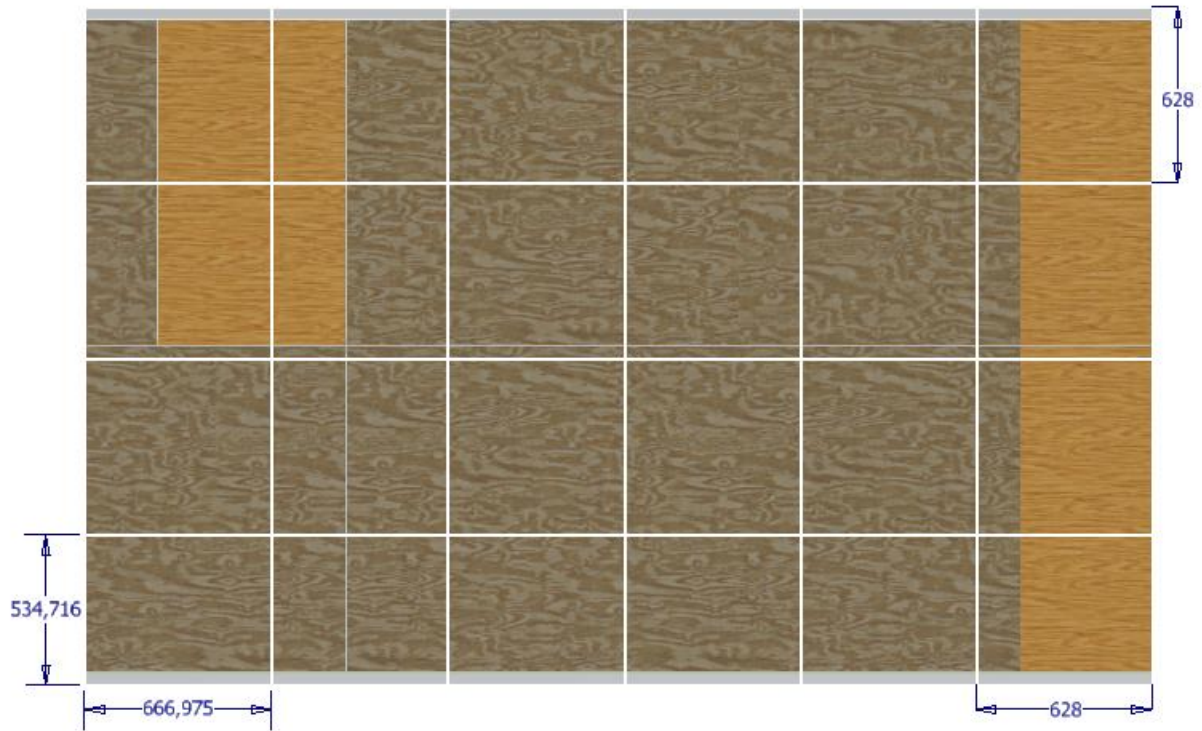

Map of damages on the bottom structure seen from top (not finished)

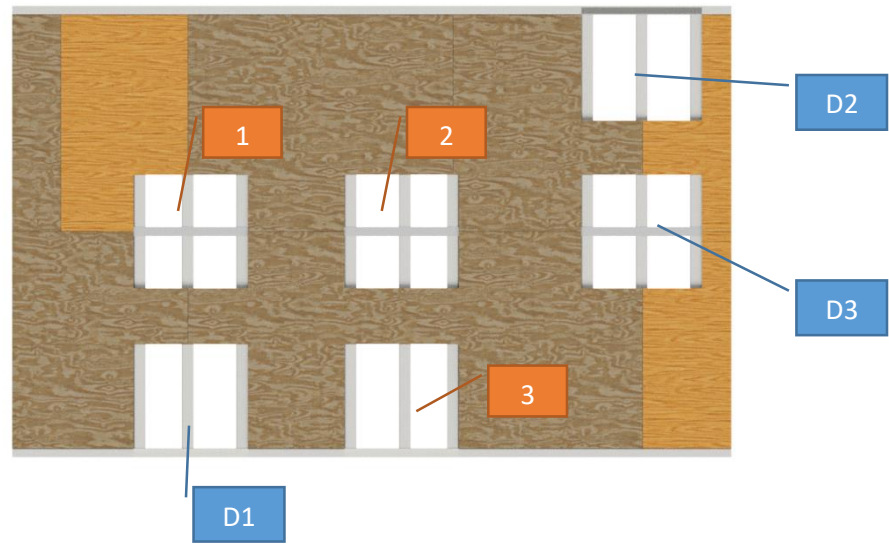

1 2 and 3 are undamaged parts

D1 D2 and D3 are damaged parts

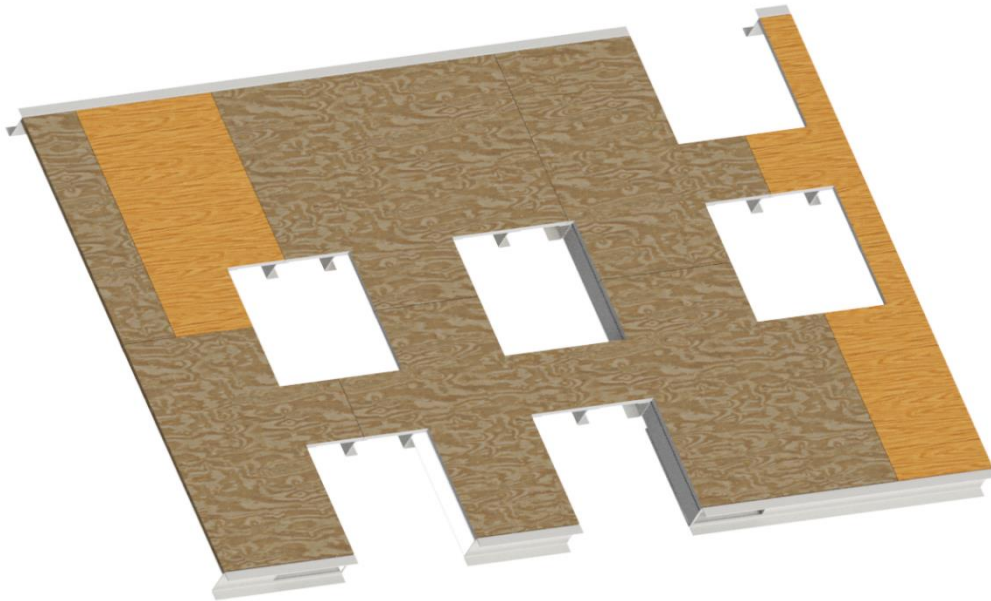
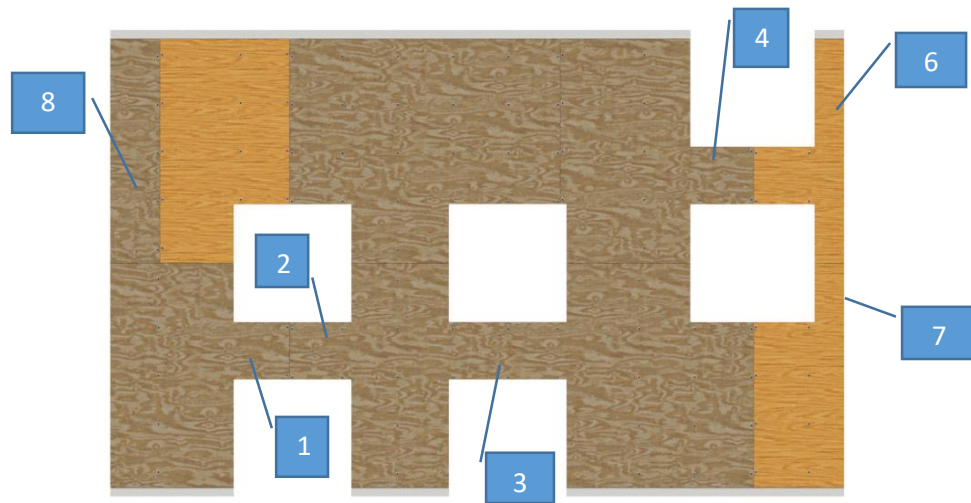

Figure showing the number of plywood plates and how the cone samples are labeled



Appendix D

CONTAIN PROJECT: Container furnace test 23rd September 2020

Status of the door before the tests



Slight smoke coming out after couple of minutes into the test



Amount of smoke increases 4 minutes, letters peel off



At 6 minutes discoloration of the door leaves



10 minutes, painture falling off. Much less smoke at this point



A bit after 14 minutes smoke starts again and at 17 minutes sealing catches fire



Severe burning of the sealing, and falling and burning on the floor. There is also burning droplets.



Burning decays



And it increases again on burning on the rubber on both sides



At 36 minutes there is very little burning left



After one hour the door leaves start glowing



The test is stopped at 1,5 hours



Appendix E: Non-exhaustive list of Danish stakeholders relevant to container ship fires

Company / organisation	Member of	Industry
DNV-GL	IACS	Classification society
ABS	IACS	Classification society
Class NK	IACS	Classification society
Bureau Veritas	IACS	Classification society
Lloyd's Register	IACS	Classification society
Fredericia Maskinmesterskole	Andet	Education and training
Aarhus Maskinmesterskole	Andet	Education and training
Maskinmesterskolen København	Andet	Education and training
MARTEC	Andet	Education and training
Marstal Navigationsskole	Andet	Education and training
RelyOn Nutec Denmark, Esbjerg	Andet	Education and training
Maersk Training, Svendborg	Other	Education and training
Nordjyllands Beredskab, Frederikshavn	Other	Education and training
Nordsjællands Brandskole, Helsingør	Other	Education and training
Viking Safety Academy, Esbjerg	Other	Education and training
SIMAC - Svendborg International Maritime Academy	Other	Education and training
LapSik	Andet	Equipment manufacturer
DASPOS	Danske Maritime	Equipment manufacturer
Novenco Fire Fighting A/S	Danske Maritime	Equipment manufacturer
Danfoss Fire Safety A/S	Eksporthforeningen	Equipment manufacturer
HydroPen	Danske Maritime	Equipment manufacturer
Automation Lab A/S	Danske Maritime	Equipment manufacturer
Green Instruments	Danske Maritime	Equipment manufacturer
Logimatic	Eksporthforeningen	Equipment manufacturer
Viking Life-Saving Equipment A/S	Eksporthforeningen	Equipment manufacturer
MP Diagnostics ApS	Danske Maritime	Equipment manufacturer
Optivation ApS	Danske Maritime	Equipment manufacturer
Miracle Q-inspect A/S	MARLOG	Equipment manufacturer

AWOTECH	MARLOG	Equipment manufacturer
VID Fire-Kill	MARLOG	Equipment manufacturer
DEN-JET Marine	Eksporthforeningen	Equipment manufacturer
H F Jensen	Eksporthforeningen	Equipment manufacturer
HIPAQ A/S	Eksporthforeningen	Equipment manufacturer
IRON Pump	Eksporthforeningen	Equipment manufacturer
Kjaerulf Pedersen a/s	Eksporthforeningen	Equipment manufacturer
Kockumation	Eksporthforeningen	Equipment manufacturer
Lindab Marine	Eksporthforeningen	Equipment manufacturer
MariTeam A/S	Eksporthforeningen	Equipment manufacturer
Nordan Marine	Eksporthforeningen	Equipment manufacturer
Scankab Cables A/S	Eksporthforeningen	Equipment manufacturer
Schneider Electric A/S Danmark	Eksporthforeningen	Equipment manufacturer
SELCO ApS	Eksporthforeningen	Equipment manufacturer
Senmatic	Eksporthforeningen	Equipment manufacturer
Wärtsilä Lyngsø Marine A/S	Eksporthforeningen	Equipment manufacturer
DESMI Pumping Technology	Danske Maritime	Equipment manufacturer
Insatech A/S	Danske Maritime	Equipment manufacturer
IRON Pump	Danske Maritime	Equipment manufacturer
Johnson Controls Denmark	Danske Maritime	Equipment manufacturer
KAIROS TECHNOLOGY ApS	Danske Maritime	Equipment manufacturer
Kjærulf Pedersen	Danske Maritime	Equipment manufacturer
PALFINGER MARINE	Danske Maritime	Equipment manufacturer
Svanebjerg Group	Danske Maritime	Equipment manufacturer
Danfoss IXA A/S	Eksporthforeningen	Equipment manufacturer
Halton Marine A/S	Eksporthforeningen	Equipment manufacturer
Shipping Lab	Other	Innovation network / consortium
Green Ship of the Future	Other	Innovation network / consortium
MARLOG	MARLOG	Innovation network / consortium

Codan Forsikring	IUMI	Insurance
Teknologisk Institut	Danske Maritime	Knowledge institution
Force Technology	Danske Maritime	Knowledge institution
Dansk Brand- og Sikringsteknisk Institut	Danske Maritime	Knowledge institution
BIMCO	BIMCO	Members' organisation
Odense Maritime Technology - OMT	Danske Maritime	Naval architectss
KNUD E. HANSEN	Danske Maritime	Naval architects
OSK-ShipTech	Danske Maritime	Naval architectss
Nordsjællands Brandskole	Andet	Other
Survey Association	Danske Maritime	Other
Den Maritime Havarikommission	Offentlig	Public authority
EMSA	Offentlig	Public authority
Søfartsstyrelsen / DMA	Offentlig	Public authority
Unifeeder A/S	Danish Shipping	Shipping
Maersk Line	Danish Shipping	Shipping
Royal Arctic Line A/S (MDC medlem)	MARLOG	Shipping
DFDS	Danish Shipping	Shipping
Blue Water Shipping A/S	Dansk Industri	Shipping
CMA CGM Denmark	Dansk Industri	Shipping
COSCO SHIPPING Lines (Nordic) A/S	Dansk Industri	Shipping
Esteph ApS	Dansk Industri	Shipping
Finnlines Danmark A/S	Dansk Industri	Shipping
Fredericia Shipping A/S	Dansk Industri	Shipping
GAC Denmark A/S	Dansk Industri	Shipping
Motorships Agencies A/S	Dansk Industri	Shipping
Safe Shipping A/S	Dansk Industri	Shipping
Schultz Shipping A/S	Dansk Industri	Shipping
Trinity Shipping Services A/S	Dansk Industri	Shipping
WeAgents Aps	Dansk Industri	Shipping

Appendix F: Container acquisition – Seaworthiness and condition

The following is an example of DBI's experiences in purchasing a seaworthy container to use for fire testing. The example is included to illustrate the issues concerning the condition of so-called *seaworthy* containers.

Introduction

DBI needed a container for fire testing purposes. In our search for a container supplier, the number of decisions needed before a container purchase took us by surprise. During the process, it was essential for us to communicate as directly and precisely as we could. We approached only one container supplier; the early stage of communication appeared straightforward and well defined. Our reason for only contacting one container supplier was time constraints on our side. We were looking for a container representative of most containers at sea with only a few defects. Such a container proved more complicated to obtain than we first understood it to be.

The container supplier

After a brief exchange of emails and phone calls, we decided to visit the company on site. The initial meeting was in English between a Danish Sales Representative from the container supplier and two employees from DBI, a French Project Manager with limited Danish skills, and an Icelandic Technical Assistant fluent in Danish, although with an accent. Communication and language later became key to what would happen to the container bought by DBI.

Language of communication

The first meeting was fruitful. The container supplier was interested in working with us and wanted to sell us a container. Because of the summer holidays, the French Project Manager stepped back from the process and handed his role over to a Danish Research Consultant from DBI. We set up a second meeting, this time in Danish, resulting in an interview about the container industry in general.

Following the interview, we did a walk-around on-site. We talked about how to handle containers on land and how to assess the state of a container. We also touched on various topics such as container life cycle, proper storage, and misdeclared cargo. The Sales Representative described how a container has an endless theoretical lifetime if taken care of properly. It is common to see Containers having a longer lifetime in areas where salaries are low, where container repairs are profitable. The conclusion to this discussion was that it was difficult to find a container representing an average ship's container. However, they had a classification scale to determine the containers' state. He proposed that we take something in the middle of its lifetime as a seaworthy container. Though most of this project's communication was in English, we decided that all communication regarding the container acquisition be changed to Danish to ease the process.

Container purchase

Before we left the Sales Representative after the second meeting, we informed him that we would like to purchase a full container. We immediately followed up with communication by email and phone in Danish through DBI's Technical Assistant. The Sales Representative offered us to cut up the container if we provided him with the information on where and how to do it. Our Technical Assistant gave the container supplier three drawings, one of the floor, one of the door, and one of the back end opposite the container door. DBI's Technical Assistant explained the need for us to get the full container for fire testing purposes.

When the container arrived at DBI's testing facilities, we soon realized that parts of the container were missing. Even the parts received did not originate from the same container. We promptly contacted the Container supplier, but he seemed unsympathetic to our concern. From his perspective, all the parts in the drawings sent by our Technical Assistant were present. It was true that everything in the drawings was there.

However, the rest of the container was still missing. The parts we had asked for came from two different sources: one was from an actual container, and the other a spare part for cut-down containers.

We learned that they scrapped the rest of the container through dialog with the container supplier's Sales Representative because they understood that we did not require the rest. As compensation, they suggested that we compromise by supplying us with parts from other containers for the tests that we needed. When we inquired about the container's missing parts, the supplier put it down to poor communication and a misunderstanding. The Danish Research Consultant from DBI learned that it had been challenging to understand DBI's Icelandic Technical Assistant. The container supplier made this claim even though the emails clearly stated it was for one full container.

After some internal discussion at DBI, we got back to the Container supplier. Interestingly enough, the story had now changed. The supplier told us that we got the spare part because of severe damage to the DBI purchased container. They still claimed that they felt they had lived up to the end of the deal. In the end, DBI reluctantly accepted the container supplier to send parts for a roof to test, as well as a considerable discount on the services provided.

Evaluating the state of a container

We decided to have the parts received evaluated by an external independent Container Consultant during our dialog with the container supplier. We contacted him to visit us at DBI's test site to look at the container parts.

He immediately confirmed our suspicion that the container's back was not of the same container that we had bought. The parts came from two different sources. We also talked to him about the quality of the container we had received. The container was near the end of its life cycle but lacked some key things that he would typically recommend for a container to go back to sea. One of these things was a lack of waterproof treatment on the underside of the container. He said that even though the container was of relatively low quality, nearing the end of its life. It would still be common to see onboard ships today.

Conclusions on the container acquisition experience

There are many lessons to learn from the container acquisition experience. It is unknown whom to blame for the mix-up of what parts of the container DBI needed.

Miscommunication

The container supplier did supply the parts shown in the drawings but failed to read and consider the emails' written information. DBI could have sent complete drawings of an entire container with each part shown how we wanted it. However, it is unquestionable that the spare part given to DBI was not the part that DBI had initially requested. It is also unknown to DBI if the container's damage occurred before or after the container supplier decided to take the container and cut it up.

A difference of opinion

It is interesting to note that the independent container consultant was of a different opinion than our original supplier of the container in terms of the state and seaworthiness. This disagreement reflects an issue in the container world. Even with written guidelines, a container's state is still a very subjective evaluation. Given that the difference of opinion can be so notable, it is reasonable to assume that the quality of containers at sea will vary significantly from ship to ship.

Appendix G: International Maritime Dangerous Goods (IMDG) code

The code classifies the dangerous goods into the following categories:

- Class 1 – Explosives
- Class 2 – Gases
- Class 3 – Flammable liquids
- Class 4 – Flammable solids; substances liable to spontaneous combustion; substances which, in contact with water, emit flammable gases
- Class 5 – Oxidizing substances and organic peroxides
- Class 6 – Toxic and infectious substances
- Class 7 – Radioactive material
- Class 8 – Corrosive substances
- Class 9 – Miscellaneous dangerous substances and articles
- Marine pollutants

Each of the classes is in detail described in terms of definitions, properties and subdivisions including special remarks.

The code then continues with giving the details on packing and tank provisions. Furthermore, a rules and procedures for consignment are given.

Next chapter of the IMDG code describes construction and testing of packaging, intermediate bulk containers (IBCs), large packaging, portable tanks, multiple-element gas containers (MEGCs) and road tank vehicles.

Chapter 7 covers provisions concerning transport operations which includes the rules for stowage, segregation, special provisions in the event of an incident and fire precautions involving dangerous goods, transport of cargo transport units on board ships, temperature control provisions etc.

Volume 2 of IMDG code ¹⁸ gives a list of the most commonly carried dangerous goods but is not exhaustive. It is intended that the list covers, as far as practicable, all dangerous substances of commercial importance. Where a substance or article is specifically listed by name in the Dangerous Goods List, it shall be transported in accordance with the provisions in the List which are appropriate for that substance or article. A "generic" or "not otherwise specified" entry may be used to permit the transport of substances or articles which do not appear specifically by name in the Dangerous Goods List.

The **2018 IMDG Code** (inc. Amendment 39-18) is in force as of January 1, 2020 (<https://www.imo.org/en/OurWork/Safety/Pages/DangerousGoods-default.aspx>).